



TOWN OF KILLINGLY, CT
PLANNING AND ZONING COMMISSION

RECEIVED
TOWN CLERK, KILLINGLY, CT
APR 17 AM 10:20

MONDAY – APRIL 20, 2020

Stephen M. Wilson

Regular Meeting
7:00 PM

***NOTE: THE MARCH 16, 2020 MEETING WAS CANCELED DUE TO COVID-19 CONCERNS
THIS AGENDA CONTAINS ONLY THOSE PUBLIC HEARINGS PREVIOUSLY SCHEDULED AND
NOTICED**

Town Meeting Room, Second Floor
Killingly Town Hall
172 Main St., Killingly

AGENDA

THE PUBLIC CAN VIEW THIS MEETING ON FACEBOOK LIVE.

GO TO www.killinglyct.gov AND CLICK ON FACEBOOK LIVE AT THE BOTTOM OF THE PAGE.

- I. CALL TO ORDER/ROLL CALL
- II. ELECTION OF OFFICERS FOR 2020
- III. SEATING OF ALTERNATES
- IV. AGENDA ADDENDUM
- V. **CITIZENS' COMMENTS ON ITEMS NOT SUBJECT TO PUBLIC HEARING** (Individual presentations not to exceed 3 minutes; limited to an aggregate of 21 minutes unless otherwise indicated by a majority vote of the Commission)

NOTE: Pursuant to Governor's Executive Order 7B, all public comments can be emailed to publiccomment@killinglyct.gov or mailed to the Town of Killingly, 172 Main Street, Killingly, CT 06239 on or before the meeting. All public comment received prior to the meeting will be posted on the Town's website www.killinglyct.gov.

NOTE: To participate in either the CITIZENS' COMMENTS OR THE PUBLIC HEARINGS – the public may join the meeting via telephone while viewing the meeting on Facebook live.

To join by phone please dial 1-408-418-9388; and use the access code 791-794-444.

- VI. COMMISSION/STAFF RESPONSES TO CITIZENS' COMMENTS

VII. PUBLIC HEARINGS – (review / discussion / action)

1) **Plan of Conservation and Development (POCD)** – The Commission has completed its review and re-write of the Town’s Plan of Conservation and Development as required under State Statute. New Plan will cover 2020-2030; and if passed the effective date will be Monday, May 4th, 2020 at 12:01 am. – **CONT. FROM 02/18/2020 AND THE CANCELED 03/16/2020 MEETING DUE TO COVID-19.**

2) **Special Permit Application #20-1233** – Rene Bernier (Pine Hill Farm, LLC /landowner); conversion of an existing chicken coop into a storage facility; 204 Hartford Pike; GIS MAP 108, Lot 34, ~5.0 acres; Low Density. Article VII, Section 700 etc., Special Permits; Section 410.2.2.o Proposed Adaptive Re-Use of an Agricultural Building – **CONT. FROM THE CANCELED 03/16/2020 MEETING DUE TO COVID-19.**

Hearings’ segment closes.
Meeting Business will continue.

VIII. UNFINISHED BUSINESS – (review / discussion / action)

1) **Plan of Conservation and Development (POCD)** – The Commission has completed its review and re-write of the Town’s Plan of Conservation and Development as required under State Statute. New Plan will cover 2020-2030; and if passed the effective date will be Monday, May 4th, 2020 at 12:01 am. – **CONT. FROM 02/18/2020 AND THE CANCELED 03/16/2020 MEETING DUE TO COVID-19.**

2) **Special Permit Application #20-1233** – Rene Bernier (Pine Hill Farm, LLC /landowner); conversion of an existing chicken coop into a storage facility; 204 Hartford Pike; GIS MAP 108, Lot 34, ~5.0 acres; Low Density. Article VII, Section 700 etc., Special Permits; Section 410.2.2.o Proposed Adaptive Re-Use of an Agricultural Building – **CONT. FROM THE CANCELED 03/16/20 MEETING DUE TO COVID-19.**

3) **Site Plan Review Application #20-1237** – Dandeneau Properties, LLC; proposed building addition and parking lot; 40 Louisa Viens Drive; GIS MAP 57, Lot 12, ~8.7 acres; Industrial Zone – **CONT. FROM THE CANCELED 03/16/20 MEETING DUE TO COVID-19.**

IX. NEW BUSINESS – (review/discussion/action)

1) **§8-24 Review Application #20-1238**; Town of Killingly Board of Education (Steven Rioux, Superintendent); replacement of existing natural turf field at Killingly High School Stadium with a new artificial turf field, (88,750 square feet) inside existing track; 226 Putnam Pike, Killingly, CT, GIS MAP 79; Lot 2; ~142 acres; Rural Development. **Review/Discussion/Action**

2) **§8-24 Review Application #20-1241**; Town of Killingly; 2020-2021 Capital Improvement Program

3) **Site Plan Application #20-1239**; 145 Alexander Parkway, LLC; construction of a 22,400 S.F. steel building for lease spaces; potential uses include contractor business & trucking business (no through terminals); 141 Louisa Viens Drive; GIS MAP 36; Lot 2.1; ~7.0 acres; Industrial Zone. **Receive, and if the application is complete, schedule it for review/discussion/action on May 18, 2020. NOTE: There is no need for a public hearing for a site plan review.**

4) **Special Permit Application #20-1240**; 145 Alexander Parkway, LLC; special permit requests under Sec. 430.1.2.c (Freight and materials trucking business and terminals) and 430.1.2.j (Contractor’s Business); 141 Louisa Viens Drive; GIS MAP 36; Lot 2.1; ~7.0 acres; Industrial Zone. **Receive, and if the application is complete, schedule it for hearing – next available date is May 18, 2020.**

THE FOLLOWING NEW BUSINESS HAS COME INTO THE P&D OFFICE SINCE MARCH 16, 2020

5) **Special Permit Application #20-1242**; Snake Meadow Club, Inc; excavation of approximately 373,000 CY of sand and gravel from approximately 19 acres of land; 567 Hubbard Road; GIS MAP 255; LOT 10; ~34 acres; Rural Development. **Receive, and if the application is complete, schedule it for a hearing – next available date is May 18, 2020.**

6) **Special Permit Application #20-1243**; Desmarais & Sons, Inc.; import of earth products for processing and screening; 145 Alexander Parkway; GIS MAP 36; Lot 1; ~26 acres; Industrial Zone. **Receive, and if the application is completed, schedule it for a hearing – next available date is May 18, 2020.**

Applications submitted prior to 5:00 PM on Monday, April 13, 2020 will be on the agenda as New Business, with a “date of receipt” of Monday, April 20, 2020 and may be scheduled for action during the next regularly scheduled meeting of MONDAY, MAY 18, 2020.

Applications submitted by 12:00 noon on Friday, April 17, 2020 will be received by the Commission (“date of receipt”) on Monday, April 20, 2020. However, these applications may not be scheduled for action on MONDAY, MAY 18, 2020, as they were submitted after the Commission’s deadline. This is in accordance with Commission policy to administer Public Act 03-177, effective October 1, 2003.

X. ADOPTION OF MINUTES – (review/discussion/action)

- 1) Special Workshop Meeting of Tuesday, February 18, 2020
- 2) Regular Meeting of Tuesday, February 18, 2020

XI. OTHER / MISCELLANEOUS – (review/discussion/action)

1) **Subdivision Application # 19-1213**; John C. D’Amato, Jr. and Ballouville Road, LLC; 41 Lot subdivision; 38 Ballouville Road (GIS MAP 63, Lot 50); and 82 Ballouville Road (GIS MAP 54, Lot 1.1); ~1.8 acres, Medium Density. **Request (dated and received 2/18/2020) for second extension of time to file MYLARS. First extension expired on Wednesday, March 4, 2020. The second and final extension would expire at the end of business on Tuesday, June 2, 2020.**

XII. CORRESPONDENCE – (review/discussion/action)

A. Zoning Enforcement Officer’s & Zoning Board of Appeal’s Report(s)

Enclosed

B. Inland Wetlands and Watercourses Agent’s Report

Enclosed

C. Building Office Report

Enclosed

XIII. ECONOMIC DEVELOPMENT DIRECTOR REPORT

XIV. TOWN COUNCIL LIAISON REPORT

XV. ADJOURNMENT

=====

II. ELECTION OF OFFICERS FOR 2020

=====

- 1) Chairman, Keith Thurlow, turns the meeting over to the Director of Planning and Development;
- 2) Director of Planning and Development, Ann-Marie Aubrey, explains the process of the election of officers;
 - a. calls for nominee(s) for the position of Chair;
 - b. calls two more times for nominee(s) for the position of Chair;
 - c. asks the nominee(s) if he/she is willing to serve;
 - d. if yes, then closes the nominations;
 - e. if no, then once again calls for nominations (if need be)
 - f. calls for a roll call vote on the nomination;
 - g. announces the result of the vote on the nomination
=====
 - h. repeats the above process for Vice-Chair and Secretary
=====
- 3) Once all the positions have been nominated and voted on the Director then turns the meeting over to the duly elected Chair

=====

VII. PUBLIC HEARINGS – (review / discussion / action)

1) **Plan of Conservation and Development (POCD)** – The Commission has completed its review and re-write of the Town’s Plan of Conservation and Development as required under State Statute. New Plan will cover 2020-2030; and if passed the effective date will be Monday, May 4th, 2020 at 12:01 am. – **CONT. FROM 02/18/2020**

=====

This is a continuation from the February 18, 2020 meeting at which time a member of the public came forth with a variety of suggested edits for the POCD. Below is staff’s input regarding those edits, etc.

1) Page 8 – Staff does recognize that many of the events listed are events that the KPRD is involved in, and there is no mention of open space activities. Staff suggests that a single lined 3rd paragraph be added that simply states – **“The Killingly Conservation Commission conducts a number of public walks and scenic back road tours throughout the year.”**

2) Page 12 – Change Policy #2 to “Promote acquisition and use of open space”. **Staff does not agree with requested change** – as this section is referring to “cultural and historical resources” – The Natural Resources Section (page 45) – there is a policy which requests the increase in the % of open space.

3) Map edits after page 14 – **Staff agrees to add those areas to the map.**

4) Page 20 – **Staff does not agree that P3–Action 3 is a duplicate of P3-Action 2** – therefore staff does not agree with the requested change.

5) Map after Page 38 – Future Land Use map – that is an issue for DEEP – the PZC and IWWC have already made their comments regarding this – **No need for any change.**

6) Page 45 – P2-Action 2 – **Staff does not agree with this** – Creating public events is a way to educate – therefore is a repetitive and no need to list.

7) Page 45 – P2-Add Action 3 – This is something that needs more research and is something that could be handled later as a proposed amendment to the POCD. **Staff does not agree to make this change currently.**

8) Page 47 – P4 – Requests new action item – **Staff believes this can be handled by adding wording** to policy 4 as follows: “...connected areas of land that provide exceptional wildlife habitat, **critical farmlands** and protection of other resources.”

9) Page 47 – P4 – Requests new action item – **Staff does not agree with this**, this request is a personal opinion as this is something that must go before the Town Council, go to Town Meeting, etc. etc. – we cannot tell the voters what to do. (must allow the town council and voters to weigh the benefits against the liabilities.

4) From Community Development – create graph of the information in the back regarding housing and regional racial population. (This graph is needed for grant opportunity funding.)

5) Received the following corrections from the CT Airport Authority – (Transportation/AIR Section)
Page 69.

- a. Substitute CT DOT w/ **“The Connecticut Airport Authority”** as owner of the Danielson Airport;
- b. Substitute the link to the master plan (www.ct.gov/dot) with (www.ctairports.org)
- c. Substitute Bradley Field with **“Bradley International Airport”**
- d. Correct the length of the runway from 3,200 ft to **“2,700 feet”**

=====

VII. PUBLIC HEARINGS – (review/discussion/action)

1) **Special Permit Application #20-1233** – Rene Bernier (Pine Hill Farm, LLC /landowner); conversion of an existing chicken coop into a storage facility; 204 Hartford Pike; GIS MAP 108, Lot 34, ~5.0 acres; Low Density. Article VII, Section 700 etc., Special Permits; Section 410.2.2.o Proposed Adaptive Re-Use of an Agricultural Building (Low Density).

=====

NOTES:

- 1) Application submitted 01/23/2020;
 - 2) Received by PZC 02/18/2020;
 - 3) Payment received 01/23/2020;
 - 4) Abutter List received 01/23/2020;
 - 5) Perimeter Survey – Pine Hill Farm LLC;
 - 6) Certified Letters to abutters Mailed on March 5, 2020;
 - 7) Legal Advertisement in Norwich Bulletin on March 3, 2020 and March 9, 2020;
 - 8) Placard was posted on site on or before Friday, March 6, 2020 per Zoning Enforcement Agent;
- =====

Staff Notes:

- 1) Recently passed the adaptive Re-Use for various zones, including the low-density zoning district – staff refers commission members to section 410.2.2.o (a copy is enclosed herewith) of zoning regs.
- 2) The building was previously used as a chicken coop;
- 3) Applicant is requesting that the structure be allowed to be used as a storage facility – which is one of the Limited Uses allowed under this regulation;
- 4) Landscape, Screening and Aesthetics – the commission should review the regulations to see if they want to add any further conditions, etc.

=====

VIII. UNFINISHED BUSINESS – (review/discussion/action)

5) **Site Plan Review Application #20-1237** – Dandeneau Properties, LLC; proposed building addition and parking lot; 40 Louisa Viens Drive; GIS MAP 57, Lot 12, ~8.7 acres; Industrial Zone.

=====

NOTES

- 1) Application received on 02/11/2020
- 2) Payment in full received on 02/11/2020
- 3) Site Plan Review Checklist received on 02/11/2020
 - * explains how the site plan meets zoning requirements
- 4) Drainage Review received on 02/11/2020
 - * awaiting comments, if any, from engineering

Special Notes

This site plan does refer to a transfer of land to make sure this addition meets zoning requirements.

The landowner of this parcel of real estate also owns the other parcel so the land transfer will take place as soon as the Commission makes its decision regarding the addition.

Staff has already informed the applicant that we will be requesting an “as built” once construction is completed – and that as built will be required to be filed with the Land Evidence Records in the Town Clerk’s Office.

Site Plan Application # _____

Date Submitted _____

Received By _____

Fee _____

SITE PLAN REVIEW APPLICATION

Procedures for Site Plan Review are explained in Article IV of the Zoning Regulations.

ALL APPLICANTS FILL OUT THIS SECTION -- PLEASE PRINT

Applicant's Name Dandeneau Properties, LLC Date _____

Address 40 Louisa Viens Drive, Dayville, CT 06241

Owner of Land Same as Applicant Date _____

Address _____

Location of Property

Street 40 Louisa Viens Drive

Tax Map Number 57 Block _____ Lot 12

Zoning District Industrial Lot Size 8.71

Proposed Activity (check those that apply)

Commercial _____ Industrial X

Other - Specify _____

New Construction _____ Addition X Alteration _____

Please explain proposed activity Proposed building addition and parking lot.

Attachments

Site and architectural plans as specified in Section 470 of the Zoning Regulations

Please provide approval letters (and date of approval from the following Commissions, Departments, agencies with this application (if applicable)

- a. Inland Wetlands and Water Courses Commission

Date of Approval N/A

- b. Zoning Board of Appeals

Date of Approval N/A

- c. Northeast District Department of Health

Date of Approval N/A

- d. Water Company

Date of Approval Pending

- e. Water Pollution Control Authority

Date of Approval N/A

- f. D.O.T. - submit letter of D.O.T. Review

- g. Other Miscellaneous Commissions, agencies (i.e., Department of Environmental Protection)

- h. Names and addresses of all abutting property owners (owners of record)

see attached

Please provide the following information:

- a. Six copies of site plan - 24"x36" at a scale of 1"=40' (See Section 470.7
- b. Architectural Plans (See Section 470.8)

- c. Fee - (a) ^{+ \$30.00 per acre for the state} \$75.00 per acre, or each part thereof; b) amendments, modifications or additions to an approved Site Plan if property boundaries remain unchanged: \$100.00 + \$30.00 per acre
- d. Name and Connecticut Registration Number of Land Surveyor and Professional Engineer - all final plans must have original signatures
- Bruce D. Woodis, LLS - CT # 13646
- David A. Smith, P.E. CT # 14173
- e. Name of Soil Scientist N/A
- f. Soil Erosion & Sediment Control Plan
- g. Detail drawings of catch basins, rip rap, erosion control measures, bituminous concrete, lighting, curbing, signs, etc.
- h. Drainage Calculations

The undersigned hereby acknowledges that this application to the best of his/her knowledge conforms to the Zoning Regulations of the Town of Killingly and that approval of the plan is contingent upon compliance with all requirements of said Regulations. The undersigned hereby authorizes the Killingly Planning and Zoning Commission, or its agents, to enter upon the property for the purpose of inspection and enforcement of said Zoning Regulations.

Signed [Signature] Date 1/30/20
 (Applicant)

Signed [Signature] Date 1/30/20
 (Owner)

The undersigned warrants and guarantees that all of the improvements as shown on the final approved site plan map will be installed in a good and workmanlike manner, and individually and severally guarantee to provide all necessary funds with respect thereto.

Signed  Date 1/30/20
(Applicant)

Signed  Date 1/30/20
(Owner)

DANDENEAU SITE PLAN REVIEW CHECKLIST

- 470.1 Bonding. The Director may require that applicants post a bond or other acceptable surety to insure completion of the required site improvements such as road or parking area construction, landscaping, grading, storm drainage and any other items, the failure of which to complete would adversely affect the environment and/or health, safety and welfare of residents of the Town.
- 470.2 Conditions of approval. Approval of a site plan review application under Section 470 of these regulations shall constitute approval conditioned upon the completion of the proposed development, in accordance with plans as approved and any conditions set forth, within a period of two (2) years after approval is given. However, the Director may require earlier compliance with any conditions, if the Director finds such compliance to be necessary for protection of the public health safety, and/or welfare. The Director shall set a date for final compliance with such conditions. Approval of the application shall become null and void in the event of failure to meet any of the time limits set in accordance with this paragraph, unless an extension of time is applied for and granted by the Director. (Amend. of 1-12-81).
- 470.3 Revisions. Any substantial revision of an approved site plan application and any reconstruction, enlargement, regarding, extension, moving or structural alteration of a building or use of land in connection with an approved site plan application, shall require submission of a site plan application as for the original application.
- 470.4 Contents of site plan. A site plan drawn to a scale of no more than forty (40) feet to the inch, showing: ***Site plan scale 1" = 40'***
- A. Existing and proposed property lines accurate to the standards of A-2 classification as defined in the Code of Practices for Standards of Accuracy of Surveys and Maps adopted December 10, 1975 as amended by the Connecticut Association of Land Surveyors, Inc. ***Land certified to Class A-2 Standards***
 - B. Names of all abutting property owners and approximate locations of buildings, wetlands, and flood plains within one hundred (100) feet of the property, including across the street. ***Property owners shown, buildings within 100' shown, no wetlands or flood plains within 100 feet.***
 - C. Location, elevation and dimensions of all existing and proposed buildings and site features. Uses including but not limited to signs, sidewalks, streets, drives, recreation facilities, parking facilities, utilities, electric, gas sanitary storm and water supply, buffer strips, landscaping, including species and size, open space, trees with a diameter in excess of eighteen (18) inches, ledge outcrops and other physical features. ***All required features and elevations shown on site plan.***
 - D. Location of all right of ways, easements and the like. ***All easements shown on plan.***
 - E. Title block in the lower right hand corner of the plan showing name(s) of property owners and applicants, date of original plan and any revision dates, zoning district of lot, and use proposed. ***Title block contains all necessary information.***

- F. North arrow. **North arrow shown.**
- G. Signature block for Planning and Zoning Commission Chairman as follows:
Site Plan # (or Special Permit #)
Date approved _____
Planning and Zoning Commission Chairman _____
Date _____ **Approval Block on Sheet 1.**
- H. Location of abutting zoning districts. **Subject property and adjoining properties all zoned Industrial.**
- I. Location map including zoning districts at a scale of 1" = 1000' **Location map shown at 1" = 2000'**
- J. Detail design of signs, lighting, retaining walls, pavement, sidewalks, catch basins, rip rap, erosion control measures, curbing, drainage facilities, etc. **Construction detail sheet #2 contains all required construction details.**
- K. Location of all driveways. Return curbs for drives accessing a town road shall have a minimum radius of 15' for multifamily and offices and 25' for commercial and industrial uses. **All proposed driveways depicted. No new entrances to Town Roads proposed.**
- L. Topographic information at two foot intervals in areas of re-grading and five foot intervals in areas of steep slopes. Additional elevations may be required if deemed necessary by the Town Engineer. **Existing and proposed topography and grading shown on site plan.**
- M. Legend giving the "Required" and "Provided" figures for each of the following: Lot area, lot width, front yard setback, side yard setback, rear yard setback, lot coverage (by percent), building height (stories and height), parking requirements. **Legend/Zoning Table showing "Required" and "Provided" are shown on Sheet #1.**
- N. Conceptual approval letters when applicable from water company, sewer authority, Inland Wetlands and Water Courses Commission, Department of Environmental Protection, Department of Health, Department of Transportation, or any other agency that has jurisdiction over the application. **Conceptual approval letters to be provided where required. DEEP, Health Department, DOT and Inland Wetlands are not applicable for this application.**
- O. Seal and original signature of the Connecticut Licensed Professional Engineer and Land Surveyor when applicable. **Seals and signatures provided.**
- P. Soil erosion and sediment control plan. **Sedimentation and erosion controls are shown on the site plan and sedimentation and erosion control notes shown on Construction Detail Sheet #2.**
- Q. Sight distances for proposed drives existing onto any town and state road. **No new proposed driveways onto Town Road.**
- R. Any other information as required by the Director.

- 470.5 Architectural plans. Preliminary architectural plans of all buildings, structures, and signs including: ***Architectural exterior views and floor plans to be provided by architect.***
- General exterior elevations — including type of materials to be used.
 - Generalized floor plans illustrating at least proposed entrances and exits.
(Amend. of 10/19/87)
- 470.6 Site plan objectives. In reviewing a site plan application the Director shall take into account the public health, safety, and welfare of the public in general and the immediate neighborhood in particular, and may prescribe reasonable conditions and safeguards to insure the accomplishment of the following general objectives.
- 470.9.1 Public safety. That all buildings, structures, uses, equipment, or material are readily accessible for fire and police protection. ***26 foot wide fire truck and emergency vehicle access provided. Continuous loop access road provided around building. Minimum clearance of 60 feet from building addition to property lines provided.***
- 470.9.2 Storm drainage. That storm drainage shall be provided for and designed in accord with standard engineering practice by a Connecticut registered professional engineer. The Director shall require that such storm drainage plans be approved by the Town Engineer. ***Storm drainage designed by Registered P.E. No additional storm water directed into existing public storm drainage system. Drainage calculations for stormwater retention and recharge provided.***
- 470.9.3 Pedestrian and vehicular access. That the plans minimize pedestrian- vehicular conflicts by providing for safe pedestrian walks especially in parking areas and adjacent to buildings. ***Handicap accessible employee walkway provided. New sidewalk adjacent to new employee parking area to provide safe pedestrian walkway.***
- 470.9.4 Noise abatement. That all machinery and devices such as ventilation fans, drying fans, air compressors, air conditioning units, etc., shall be shielded and insulated in a manner which shall deaden the noise and deflect sound waves away from abutting premises. ***All new machinery to be located within the building addition.***
- 470.9.5 Other pollution or related problems. That the obstruction of light or air, or the emission of light, smoke, odor, gas, dust or vibration in noxious or offensive quantities shall be minimized. ***No additional emissions of dust or any other type are proposed. New building lighting on exterior of building and parking lot features dark sky and cut-off type of lighting to minimize light pollution.***
- 470.9.6 Landscaping and screening. That the general landscaping and screening of the site provides adequate tree plantings, ground cover and buffering of adjacent residential districts or other properties with shrubs or fencing as the Director deems necessary. ***All efforts are being applied to save existing tree and shrub plantings. Proposed addition is located approximately 500' from Louisa Viens Drive at a lower elevation than the existing building with limited visibility from the road. No adjacent residential districts or properties require buffering, and minimal landscaping is proposed.***

470.9.7 Neighborhood impact. That the overall effect on property values and utilization of neighborhood properties do not have a substantial adverse effect. ***The proposed building addition is located to the side and rear of the existing building and is located in an industrial area. There should be no potential adverse affect on adjacent property values or the utilization of neighborhood properties.***

470.9.8 Architectural and aesthetic impact. That the basic design of the proposed uses, buildings or development; the relationship between the buildings and the land; the relationships between uses and between buildings or structures; the overall physical appearance of the proposed use, building or development shall be in general harmony with the character of the surrounding neighborhood and will not serve to blight or detract from abutting residences or other property. ***The building addition and proposed parking and grading will be in keeping with the existing building and parking areas and the overall physical appearance of proposed building and development will continue to be in general harmony with the character of the surrounding neighborhood.***

470.e. Zoning regulations. Other sections of the Killingly Zoning Regulations shall apply in the consideration of a site plan review.

470.9 Nothing herein shall prohibit the Director of Planning and Development from submitting any such site plan review application to the commission for its review.
(Effective 01-10-01)

Dandeneau Properties, LLC.

Louisa Viens Drive
Killingly, CT

Drainage Review 2/7/2020

Storm Water Drainage Calculations for Proposed 47,076 sf Addition and associated parking (proposed actual and deferred) and proposed steps to eliminate off-site Storm Water impacts.

Existing site drainage system appears to be adequate for the building and parking presently existing at this location. A original portion of the collection systems flows to the Municipal Storm Sewer, while newer parking area is directed to an on-site retention basin.

These calculations address only the proposed new condition. The associated site plan provides for on-site storage and recharge of all runoff from new impervious surfaces (ie. Additional Roof area and additional parking, both new spaces and deferred spaces)

The study area can be divided into five catchment areas identified as CB#1, CB#2, CB#3, CB#4 and Roof.

| Watershed Identifier | Watershed Area |
|----------------------|----------------|
| CB#1 | 0.298 acres |
| CB#2 | 0.478 acres |
| CB#3 | 0.055 acres |
| CB#4 | 0.248 acres |
| Roof | 1.080 acres |

Total Impervious cover (proposed) = 98,100 sf.

Sizing the Drainage System -Storage

25 year, 5 min Storm has an intensity of 7.2 in/hour or 0.6 in per 5 minutes

$$Q = C \times I \times A = 0.9 \times 7.2 \text{ in/hour} \times \text{Area} =$$

| Watershed Identifier | Watershed Area | $Q = C \times I \times A = 0.9 \times 7.2$ in/hour x Area = | Volume generated |
|----------------------|----------------|--|------------------|
| CB#1 | 0.298 acres | 1.93 cfs | 579 cu. ft. |
| CB#2 | 0.478 acres | 3.10 cfs | 930 cu. ft. |
| CB#3 | 0.055 acres | 0.35 cfs | 105 cu. ft. |
| CB#4 | 0.248 acres | 1.61 cfs | 483 cu. ft. |
| Roof | 1.080 acres | 7.00 cfs | 2100 cu. ft. |

CB# 4 drains directly to the existing retention basin rather than the proposed recharge structure. This runoff passes through an isolation chamber that can be immediately closed in the event of a spill at the loading dock area. The existing recharge basin is proposed to be expanded to provide this the required additional storage volume.

The remaining watersheds will be directed to a proposed recharge 'galley' under the proposed driveway on the east side of the addition. The roof leaders will connect directly into the galley, while the parking areas will drain to the proposed catch basins and manholes before being introduced into the galley. An isolation chamber will be provided downstream of the proposed southerly loading dock, providing the opportunity to immediately stop water flow into the galley in the event of a spill.

The total required storage volume to accommodate a 25 year storm of 5 minute duration is the sum of flow calculated for CB#1, CB#2, CB#3 and the Roof or 3714 cu. ft.

The recharge Galley consists of 200 linear feet of 4x4x4 concrete septic system galley units backfilled with 4' of 2" stone along each side wall. This provides 6400 cu. ft of storage to receive this intense short duration design storm. REQUIREMENT SATISFIED.

Sizing the Drainage System -Recharge

In the event of a 25 year, 24 hour storm, the rainfall estimate is 5.5" over a 24 hour period or 0.23 iph.

| Watershed Identifier | Watershed Area | $Q = C \times I \times A = 0.9 \times 0.23$ in/hour x Area = | Volume generated over 24 hours |
|----------------------|----------------|---|-----------------------------------|
| CB#1 | 0.298 acres | 0.06 cfs | 5184 cu. ft. |
| CB#2 | 0.478 acres | 0.10 cfs | 8640 cu. ft. |
| CB#3 | 0.055 acres | 0.01cfs | 864 cu. ft. |
| CB#4 | 0.248 acres | 0.05 cfs | 4320 cu. ft |
| Roof | 1.080 acres | 0.22 cfs | 19,008 cu. ft. |

The total volume directed to the recharge galleys during a 25 year storm of 24 hour duration is the sum of flow calculated for CB#1, CB#2, CB#3 and the Roof or 33,696 cu. ft. The first 3714 cu. ft. will be storage, the remaining 29,982 cu. ft must be recharged.

Soil in this area reported to have a conductivity of at least 10-20 ft/day

Using $K = 10\text{ft/day}$ – we need 3499 sq ft sidewall/bottom area

Using $K = 20\text{ft/day}$ – need 1750 sq ft sidewall/ bottom area

200 linear feet of Galley provides 2400 of bottom area and 1600 sf of sidewall area for a total of 4000 sf. REQUIREMENT SATISFIED.

Conclusion –

**The proposed recharge unit will be able to store the 25 year 5 minute intense storm in the available volume
The proposed recharge unit will be able to recharge to the native soil the 25 year 24 hour storm with a soil permeability of 10 ft/day or greater.**

**David A. Smith, PE LS
Principal Engineer for
KWP Associates**

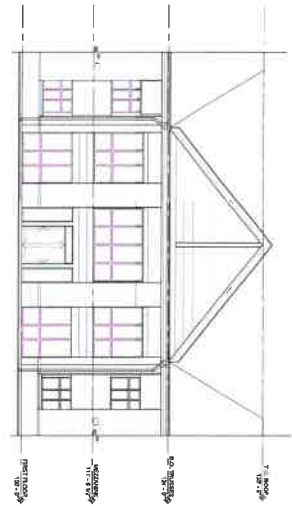

1 FRONT ENTRANCE ELEVATION (EXISTING)
 SCALE = 1/8" = 1'-0"
 (FOR REFERENCE ONLY)

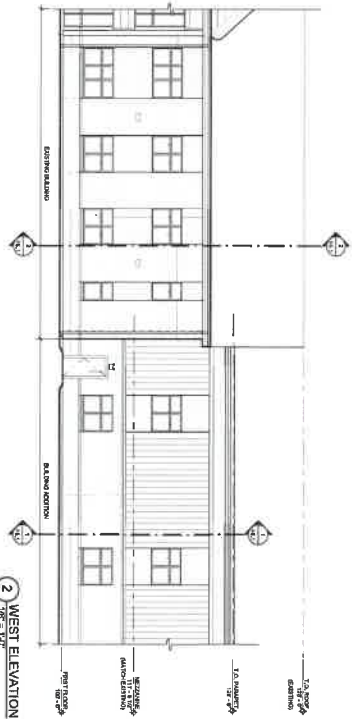

2 WEST ELEVATION
 SCALE = 1/8" = 1'-0"

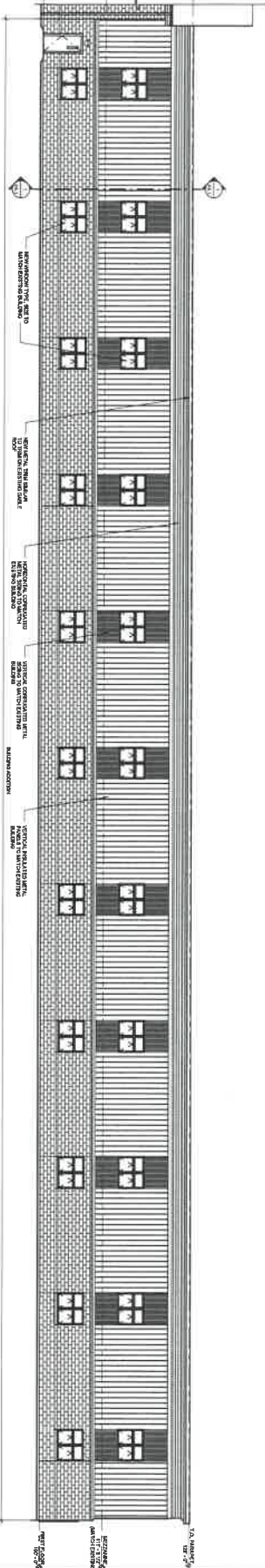

3 WEST ELEVATION
 SCALE = 1/8" = 1'-0"

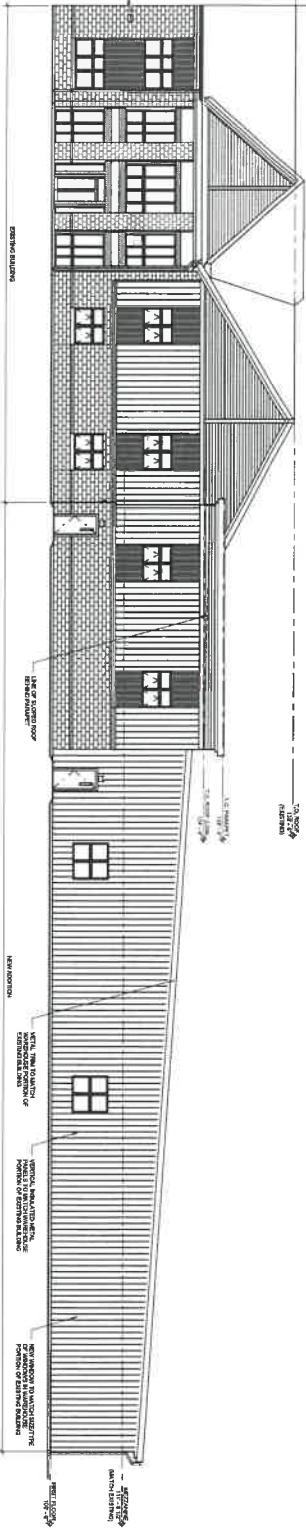

4 SOUTH ELEVATION
 SCALE = 1/8" = 1'-0"

VISION ARCHITECTS
 225 CHERRY DRIVE • PLYMOUTH, RI 02865 • TEL: 401-443-7771 • FAX: 401-443-7772 • VO: 401-443-7773 • E: info@visionarchitects.com

PUTNAM PLASTICS BUILDING ADDITION
 DANDENEAU PROPERTIES, LLC
 40 LOUISA VIENS DRIVE
 DAYVILLE, CT 06241

PROJECT STATUS:
 PRELIMINARY
 NOT FOR
 CONSTRUCTION

| | |
|--------------|----------|
| DATE: | 3/1/2025 |
| PROJECT NO.: | 1313 |
| DATE: | 3/1/2025 |
| PROJECT NO.: | 1313 |
| DATE: | 3/1/2025 |
| PROJECT NO.: | 1313 |

REVISIONS:

| | | |
|-----|----------|-------------------|
| NO. | DATE | DESCRIPTION |
| 1 | 3/1/2025 | ISSUED FOR PERMIT |

DESIGNED BY: [Name]
 DRAWN BY: [Name]
 CHECKED BY: [Name]
 APPROVED BY: [Name]

A5.1

JOB NAME _____

TYPE _____

WTM/WRM/WBM-MEDIUM CUTOFF WALL PACK

50-150 watt Metal Halide
35-150 watt High Pressure Sodium
26-42 watt Compact Fluorescent

WL-43170

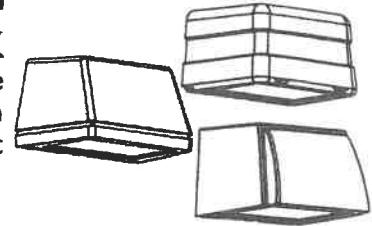

The Medium Full Cutoff Wall Pack offers a sleek design and cutoff performance with a wide range of uses. It delivers the lighting needed for the exteriors of retail buildings, businesses, walkways, underpasses or entrance doors.

ORDERING MATRIX

SAMPLE CATALOG NUMBER: WTM42CDU-FWT-LP

| | | | | | |
|------------------------------------|--|--|--|--|---|
| | | | | | |
| FAMILY WTM WRM WBM | LAMP SOURCE C - Compact Fluor. Single Lamp D - Compact Fluor. Dual Lamp M - Metal Halide S - High Pressure Sodium | VOLTAGE 12 - 120 20 - 208 24 - 240 27 - 277 48 - 480 MT - 120/208 240/277 U - Universal 120/277 volts 50Hz or 60Hz (CFL or Electronic HID) TT - 120/277/347 | OPTICS SC2 - Wide Distribution (not available with CFL) FWT - Forward Throw | PAINT COLORS BLANK - Dark Bronze Textured WT - White Textured BK - Black Textured AL - Silver Alum. Textured NP - Grey Alum. Textured GY - Industrial Gray Textured (consult factory for other colors) | OPTIONS (add as suffix) LP - Lamp with fixture WDF - Wired Double Fuse ⁴ WSF - Wired Single Fuse ⁴ PE - Photo Control (not available in 480v) PCR - Photo Control Receptacle ¹ Q - Quartz Standby ² QEM - Quartz Emergency ³ QTD - Quartz Time Delay ³ BDL940/E - Integral Emergency Ballast ⁷ (single 42W or dual 32W max.) B4CF1 - Integral Cold Temp Emergency Ballast ⁷ WEB - HID Electronic MH Ballast (100W max.) |

Footnotes:
¹Order Twist Lock Photo Control separately
²120v High Pressure Sodium Only
³Prewired by factory
⁴Requires 120 volt secondary power supply
⁵Use with 208, 240, and 480 volt.
⁶Use with 120, 277, and 347 volt.
⁷Compact fluorescent only

ACCESSORIES (order separately)

RDA-WTM - Replacement Door Assembly (WTM)
 RDA-WRM - Replacement Door Assembly (WRM)
 RDA-WBM - Replacement Door Assembly (WBM)
 PC-MT - Photo Control Twist Lock, Multi-volt (must have PCR Option)

PC-48 - Photo Control Twist Lock, 480 volt (must have PCR Option)
 PCR-SC - PCR Shoring Cap
 (For additional descriptions of Wall Light accessories refer to sheet number OA-50030.)

General Notes:
 All options are factory installed.
 Medium Base lamp only for HID.
 GX24q lamp base for compact fluorescent
 All accessories are field installed.
 Data subject to change without notice.
 Warning: Refer to and follow the lamp manufacturer's warnings and instructions.

DIMENSIONS

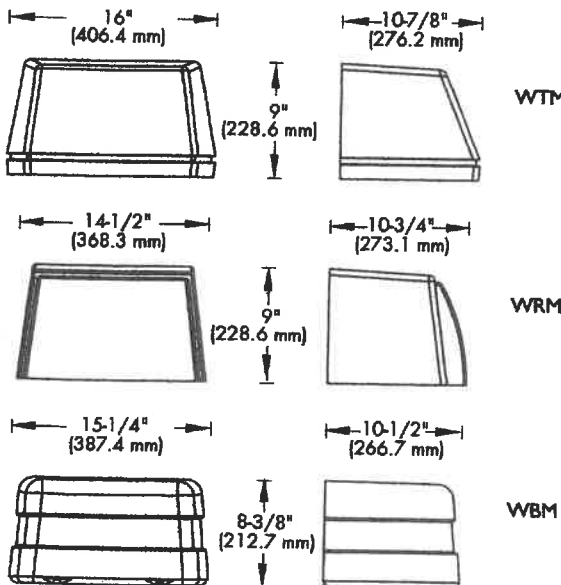

WEIGHT = 22 lbs. (max.)

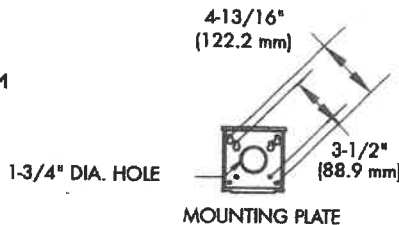

ENERGY DATA

| HIGH PRESSURE SODIUM HX-HPF BALLAST INPUT WATTS |
|--|
| 35 watt-46 watts |
| 50 watt-66 watts |
| 70 watt-91 watts |
| 100 watt-130 watts |
| 150 watt-188 watts |
| METAL HALIDE HX-HPF BALLAST INPUT WATTS |
| 50 watt-72 watts |
| 70 watt-90 watts |
| 100 watt-129 watts |
| 150 watt-189 watts |
| COMPACT FLUORESCENT |
| 26 watt-29 watts |
| 32 watt-36 watts |
| 42 watt-46 watts |
| (2) 26 watt-55 watts |
| (2) 32 watt-68 watts |
| (2) 42 watt-93 watts |

RECEIVED

FEB 18 2019

PLANNING & ZONING DEPT.
TOWN OF KILLINGLY

PHILIPS

Store

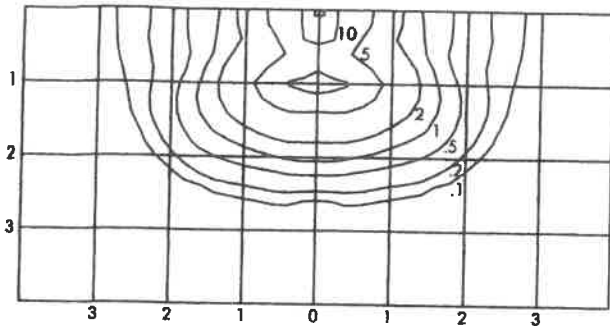

UNITS SHOWN IN TERMS OF MOUNTING HEIGHT
INITIAL FOOTCANDLES SHOWN

CATALOG NUMBER: WTM150M-FWT
 TEST NUMBER: 28625P
 LAMP: METAL HALIDE
 WATTAGE: 150
 LUMENS: 12,500
 TILT ANGLE: 0°
 MOUNTING HEIGHT: 15 FEET

| LIGHT LEVEL MULTIPLYING FACTORS | |
|------------------------------------|------------|
| MOUNTING HEIGHT | MULTIPLIER |
| 25' | 0.36 |
| 20' | 0.56 |
| 15' | 1.00 |
| 12' | 1.56 |
| 10' | 2.25 |
| 8' | 3.52 |

ADDITIONAL TEST NUMBERS

| DESCRIPTION/CATALOG NUMBER | TEST NUMBER |
|----------------------------|-------------|
| WTM035S-FWT | 28627 |
| WTM050S-FWT | 28627P |
| WTM070S-FWT | 286271 |
| WTM100S-FWT | 28626P |
| WTM150S-FWT | 28626 |
| WTM050M-FWT | 28624 |
| WTM070M-FWT | 28624P |
| WTM100M-FWT | 28625 |
| WTM42CC-FWT | 28634 |
| WTM42CD-FWT | 28633 |

ADDITIONAL TEST NUMBERS

| DESCRIPTION/CATALOG NUMBER | TEST NUMBER |
|----------------------------|-------------|
| WTM035S-SC2 | 28628 |
| WTM050S-SC2 | 28628P |
| WTM070S-SC2 | 286281 |
| WTM100S-SC2 | 28629P |
| WTM150S-SC2 | 28629 |
| WTM050M-SC2 | 28631 |
| WTM070M-SC2 | 28631P |
| WTM100M-SC2 | 28630 |
| WTM150M-SC2 | 28630P |

PRODUCT FEATURES

Certified to meet UL 1598 standards for wet location and 25°C ambient for all lamp wattages listed.

1. Heavy duty die cast aluminum housing.
2. Die cast aluminum door frame with clear tempered glass lens that is thermal and shock resistant.
3. Precision formed or segmented aluminum reflector.
4. Silicone gasketing provides protection against moisture.
5. Quick mount wall plate mounts directly to 3-1/2" octagon or 4" square outlet box for easy installation.
6. Polyester powder finish for impact, corrosion and UV resistance.

Five Year Limited Warranty.

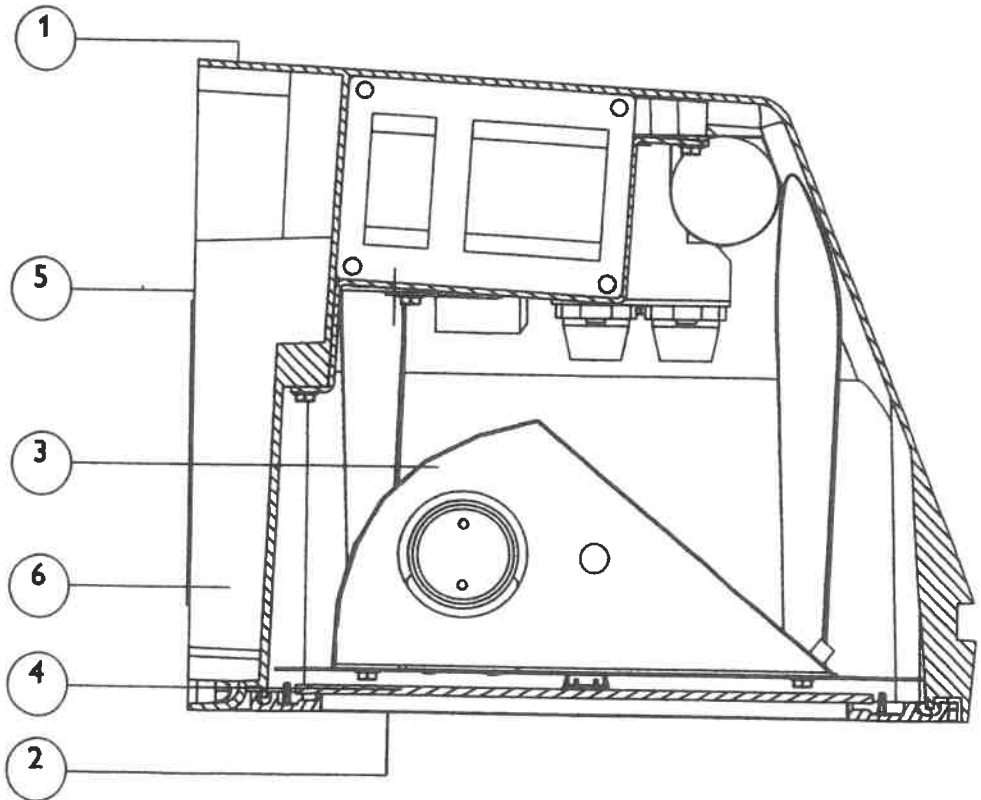

Some luminaires use fluorescent or high intensity discharge (HID) lamps that contain small amounts of mercury. Such lamps are labeled, "Contain Mercury" and/or the symbol "HG". Lamps that contain mercury must be disposed of in accordance with local requirements. Information regarding lamp recycling and disposal can be found at www.lamprecycle.org



© 2013 Koninklijke Philips Electronics N.V. All rights reserved.
 Specifications are subject to change without notice.

WL-43170 03/13

Philips Lighting Company
 200 Franklin Square Drive
 Somerset, NJ 08873
 Phone: 855-486-2216

www.philips.com/luminaires

Philips Lighting Company
 281 Hillmount Road
 Markham ON, Canada L6C 2S3
 Phone: 800-668-9008

www.philips.com/luminaires

IX. NEW BUSINESS – (review/discussion/action)

1) **58-24 Review Application #20-1238**; Town of Killingly Board of Education (Steven Rioux, Superintendent); replacement of existing natural turf field at Killingly High School Stadium with a new artificial turf field, (88,750 square feet) inside existing track; 226 Putnam Pike, Killingly, CT, GIS MAP 79; Lot 2; ~142 acres; Rural Development. **Review/Discussion/Action**

See letter submitted by the applicant.

Applicant will have a representative at the meeting to present and discuss this matter.



550 North Main Street
Suite 6
Attleboro, MA 02703
Phone: 508.659.7020
Fax: 508.659.7021

March 11, 2020

Ms. Ann-Marie Aubrey, Director, Planning and Development
Town of Killingly Planning and Zoning Commission
172 Main Street
Killingly, CT 06239

RECEIVED

MAR 13 2020

PLANNING & ZONING DEPT.
TOWN OF KILLINGLY

RE: ~~Killingly Site Plan Application~~ and CGS 8-24 Notification to local Planning Authority for
Killingly High School Stadium Field Artificial Turf Renovation
226 Putnam Pike, Killingly, CT
Map 79, Lot 2
CPH Job Number: Z6582.ARC

Dear Ms. Aubrey:

Please accept the attached application and plan for the above project. The Killingly Board of Education is undertaking the above project to upgrade the existing Killingly High School Stadium field to an Artificial Turf field from natural turf.

Overall Project

The project will cover 88,750 SF of field renovation/replacement within confines of the existing running track at the KHS Stadium field.

The project will entail the installation of Erosion and Sedimentation Control BMPs first, excavation of up to 24-inches of material from the field footprint, fine grading and replacement of the new field typical section in the exact footprint of the existing field.

Drainage Collection, Management and Conveyance

Some subsurface drainage control and conveyance elements and pipes will be added to facilitate the field drainage but will match the pre-existing drainage flow patterns, rates and volumes.

Wetlands / Upland Review Application

Because the project contains some work with the Upland Review area governed by the Town of Killingly Inland Wetlands and Watercourses Regulations and Commission we have made application to them for review and approval of the plan. As soon as we have obtained that approval, we will provide a copy to you for your consideration and files

Erosion and Sedimentation Controls

The construction activities will be preceded by the installation of Erosion and Sedimentation Control BMPs to control sediment laden discharges and limit them to the greatest extent possible during construction. Those measures, locations and specifications are provided on the design drawing and we will monitor the contractor's installation and maintenance of those measures during construction for compliance with the CTDEEP NPDES General Permit.



This letter and the attached plans are to request your approval of the work for construction. We anticipate the construction will be 90 days. We expect it will be done Spring and Summer of 2020 and be ready for use in September 2020.

We are also requesting waiver of the application fee as the applicant is a Town Agency.

We look forward to presenting the project to you and are available to provide any additional input or information you may need.

Sincerely,
CPH Design, Inc.



Alan R. Carpenter, PE
Vice President.

cc. Steven Rioux, Killingly Superintendent of Schools
Elise Guari, Principal Killingly High School
Kevin Marcoux, Athletic Director Killingly High School
Andrew Dyjak, Principal, FieldTurf

CAPITAL BUDGET (S)

1. TOWN OF KILLINGLY
2. BOARD OF EDUCATION

MISCELLANEOUS

CIP PROGRAM

CAPITAL BUDGET

DESCRIPTION

The Capital Budget is a listing of all recommended capital projects proposed for the next fiscal year. By definition, a Capital Project is a project that helps maintain or improve a Town asset, often called infrastructure. To be included in the Capital Budget, a project must meet ONE of the following requirements (criteria):

- It is a new construction, expansion, renovation, or replacement project for an existing facility or facilities. The project must have a total cost of at least \$10,000 over the life of the project. Project costs can include the cost of land, engineering, architectural planning, and contract services needed to complete the project.
- It is a purchase of major equipment (assets) costing \$50,000 or more with a useful life of at least 10 years.
- It is a major maintenance or rehabilitation project for existing facilities with a cost of \$10,000 or more and an economic life of at least 10 years.

The Capital Outlay amount listed in the Town's expenditures and in the Capital Budget is the Town's General Fund Contribution for that fiscal year. The itemized list of funding sources, when approved on adoption of the General Government Budget, authorizes the acceptance of the non-general government contribution funds. The list of projects is matched to funding sources in the Capital Improvement Program. When any non-general fund contribution funding is approved, the project funds as contained in the Capital Budget are appropriated.

APPROVED BUDGET DETAIL

Below is a summary of financing for F20-21.

| EXPENDITURE CATEGORY | FY 20-21 | FUNDING LEGEND | FY 20-21 |
|-----------------------------------|--------------------|-------------------------------|--------------------|
| Road Construction | \$307,949 | Unimproved Town Aid | \$50,000 |
| Highway | \$50,000 | Improved Town Aid | 307,949 |
| Bridges | \$0 | LOCIP | \$150,000 |
| Public Buildings | \$150,000 | Bond Funds | 40,500 |
| Parks & Recreation | \$0 | Grants Funds | \$0 |
| Economic & Community Development | \$0 | General Fund | \$0 |
| Planning & Development | \$0 | Sewer Fund | 210 |
| Schools | 135,000 | State Education Grants | \$404,000 |
| Water Pollution Control Authority | \$404,000 | Reallocation of Capital Funds | \$94,500 |
| | \$1,046,949 | | \$0 |
| | | | \$1,046,949 |

TOWN OF KILLINGLY CAPITAL IMPROVEMENT PROGRAM 2021

GENERAL GOVERNMENT PROJECTS

ROAD CONSTRUCTION

Road Renewal - Unimproved Roads
Road Renewal
Cranberry Bog Road

FUNDING SOURCE

HIGHWAYS
Storm Drainage Improvements
Guardrail Replacement
Sidewalks

PUBLIC BUILDINGS

Public Works Garage Doors
Bugbee Building Improvements

General Government Projects

Funding Source

| | | | |
|---|-----------------------------------|------|-----|
| 1 | General Fund | 100% | (6) |
| 2 | Bond Funds | 100% | (6) |
| 3 | LOCFP | 100% | (6) |
| 4 | Grants Funds | | |
| 6 | State Aid - Unimproved Road (TAR) | | |
| 6 | State Aid - Improved Road (TAR) | | |
| 7 | Reallocated Capital Funds | | |
| 8 | Capital Reserve | | |
| | General Government Revenue | | |

BOARD OF EDUCATION PROJECTS

Killingly Westfield Ave Facility
Killingly Memorial School
Killingly Central School
Killingly Intermediate School
Killingly High School
Goodyear Early Childhood Learning Center

Board of Education Projects

Funding Source

| | | | | | |
|---|----------------------------|-----|-----|-----|-----|
| 2 | Bond Funds | 30% | (2) | 70% | (5) |
| 1 | General Fund Contribution | 30% | (2) | 70% | (5) |
| 5 | State Education Grants | 30% | (2) | 70% | (5) |
| | Board of Education Revenue | 30% | (2) | 70% | (5) |

WATER POLLUTION CONTROL AUTHORITY/PROJECTS

| | | | |
|-----|--|------|-------|
| 210 | Capital Projects/Equipment | 100% | (210) |
| 210 | Sewer Replacement | 100% | (210) |
| | Water Pollution Control Authority Projects | | |
| | Funding Source | | |
| 210 | Sewer Fund | | |
| | Water Pollution Control Authority Revenue | | |

CAPITAL IMPROVEMENT PROGRAM SUMMARY

General Government Projects
Board of Education Projects
Water Pollution Control Authority Projects
TOTAL PROJECTS

507,949
135,000
404,000
1,046,949

TOWN OF KILLINGLY CAPITAL BUDGET

ROAD CONSTRUCTION

Funding Summary

| | Funding Source | FY 2021 - 2025 | | | | | Total |
|---------------------------------|----------------|----------------|------------------|------------------|------------------|------------------|------------------|
| | | FY21 | FY22 | FY23 | FY24 | FY25 | |
| Road Renewal - Unimproved Roads | (6) | 50,000 | 50,000 | 50,000 | 50,000 | 50,000 | 250,000 |
| Road Renewal | (6) | 57,949 | 100,000 | - | 250,000 | 250,000 | 657,949 |
| Cranberry Bog Road | (6) | 200,000 | 150,000 | 250,000 | - | - | 600,000 |
| Maple Street Phase I, II, III | (4) | - | 1,200,000 | 1,300,000 | 2,000,000 | 2,000,000 | 6,500,000 |
| Bailey Hill Road | (4) | - | - | - | - | 500,000 | 500,000 |
| Louisa Viens | (4) | - | - | - | - | 1,000,000 | 1,000,000 |
| Total | | 307,949 | 1,500,000 | 1,600,000 | 2,300,000 | 3,800,000 | 9,507,949 |

Project Comments

Road Renewal Unimproved Roads - The purpose of the Unimproved Roads program is to pave unimproved (dirt) roads which either cause severe maintenance problems or are experiencing increased traffic due to development. The Unimproved Town Aid Road funds for this year are being designated to provide improvements to Chase Road, Roth Road, a portion of Stone Road and other unimproved roads. The unpaved portions of Chase and a portion of Stone Road require increased maintenance in order to provide for public safety. Projects would improve Chase Road and the unpaved portion of Stone Road west of the intersection with Chase Road including drainage improvements, grading and paving and is intended to be implemented over a period of several years.

Road Renewal - The Road Renewal Program provides for an on-going pavement resurfacing schedule for the Town's 121 miles of paved roads. This program helps the Town avoid costly reconstruction due to deferred maintenance. In recent years, the Town has been very committed to this program, which is funded through a variety of sources. Town aid funds will be used for resurfacing various streets that are in need. The Engineering Department and the Highway Department are commencing a road evaluation project which will establish a road resurfacing/rebuilding program.

Cranberry Bog Road - This project would include the section of Cranberry Bog Road that connects Cook Hill Road to Coomer Hill Road. This project is projected to take place during the course of several construction seasons. It will start with adding drainage structures to take care of the current water and ice issues. Once those are in place the road will be reclaimed to add base stabilization and repaved.

Maple Street & Upper Maple Street Phase I, II & III - The section of Maple and Upper Maple Street that connects Rt 6 and Rt 101 is heavily traveled and in need of upgrades. This project is intended to be implemented over a period of several years and would include pavement restoration and pedestrian improvements. Sources of funding are anticipated to be LOTCIP (Local Transportation Capital Improvement Program) or BUILD (Better Utilizing Investments to Leverage Developments).

Bailey Hill Road - Bailey Hill Road runs north and south as a local connector road between Route 101 and Route 6. There are numerous drainage and road improvement issues that need to be addressed in order to provide an adequate level of service for the community. The project is anticipated to take several years to complete.

Louisa Viens Road - This road is in the industrial park and connects to Lake Road with Alexander Parkway. As a result of the heavier traffic for this roadway the road is in need of complete rebuilding. The catch basins have been replaced in this section. However the roadway has not been addressed. This project will also require several years to complete.

TOWN OF KILLINGLY CAPITAL BUDGET

Funding Schedule

| <i>Funding Sources</i> | FY21 | FY22 | FY23 | FY24 | FY25 | TOTAL |
|--|----------------|------------------|------------------|------------------|------------------|------------------|
| State Aid - Unimproved Roads (TAR) (6) | 50,000 | 50,000 | 50,000 | 50,000 | 50,000 | 250,000 |
| State Aid - Improved Roads (TAR) (6) | 257,949 | 250,000 | 250,000 | 250,000 | 250,000 | 1,257,949 |
| Grant Funds (4) | - | 1,200,000 | 1,300,000 | 2,000,000 | 3,500,000 | 8,000,000 |
| TOTAL | 307,949 | 1,500,000 | 1,600,000 | 2,300,000 | 3,800,000 | 9,507,949 |

TOWN OF KILLINGLY CAPITAL BUDGET

HIGHWAYS

Funding Summary

| Funding Source | FY 2021 - 2025 | | | | | Total |
|-----------------------------|----------------|---------------|---------------|---------------|---------------|----------------|
| | FY21 | FY22 | FY23 | FY24 | FY25 | |
| Storm Drainage Improvements | (6) | 20,000 | 20,000 | 20,000 | 20,000 | 100,000 |
| Guardrail Replacement | (6) | 20,000 | 20,000 | 20,000 | 20,000 | 100,000 |
| Sidewalks | (6) | 10,000 | 10,000 | 10,000 | 10,000 | 50,000 |
| Total | 50,000 | 50,000 | 50,000 | 50,000 | 50,000 | 250,000 |

Project Comments

Storm Drainage - The Storm Drainage Improvement Program was started in 1991. It is designed to address miscellaneous spot drainage problems throughout the Town. Funding is applied on an as-needed basis.

Guide Rail Replacement - The Guide Rail Replacement program allows for the replacement of seriously deteriorated guide rail with metal beam type guide rail and at selected locations where conditions dictate, new guide rail.

Sidewalks - The purpose of the Sidewalk program is to provide an ongoing improvement and maintenance schedule for sidewalks in the Town. There are existing funds in the budget to continue the program for this year.

Funding Schedule

| Funding Sources | FY21 | FY22 | FY23 | FY24 | FY25 | TOTAL |
|--------------------------------------|---------------|---------------|---------------|---------------|---------------|----------------|
| State Aid - Improved Roads (TAR) (6) | 50,000 | 50,000 | 50,000 | 50,000 | 50,000 | 250,000 |
| TOTAL | 50,000 | 50,000 | 50,000 | 50,000 | 50,000 | 250,000 |

TOWN OF KILLINGLY CAPITAL BUDGET

BRIDGES

Funding Summary

| | Funding Source | FY 2021 - 2025 | | | | | Total |
|----------------------------|----------------|----------------|---------|------|-----------|------|-----------|
| | | FY21 | FY22 | FY23 | FY24 | FY25 | |
| Cotton Road Bridge | (2) & (4) | - | - | - | 2,500,000 | - | 2,500,000 |
| Peeptoad Stone Arch Bridge | (2) & (4) | - | 800,000 | - | - | - | 800,000 |
| North Street Bridge | (2) & (4) | - | - | - | 1,200,000 | - | 1,200,000 |
| Total | | - | 800,000 | - | 3,700,000 | - | 4,500,000 |

Project Comments

Cotton Road Bridge - This bridge crosses the Quinebaug River connecting the Towns of Killingly and Pomfret. The Connecticut Department of Transportation has identified areas of concern with the bridge. The replacement of this bridge will require an inter-municipal agreement. Therefore * planning work should begin early. Addressing some of the areas identified in the CDOT inspection report may prolong the life of the bridge and reduce overall costs.

Peeptoad Road Stone Arch Bridge - This is a historical Stone Double Arch Bridge on Peeptoad Road in Dayville. The Bridge was built in or about 1850. * This bridge was rated as poor in the inspection performed by the Connecticut Department of Transportation (CDOT) in 2012. Partial funding to design and rebuild the bridge is currently available through either the Local State or Federal Bridge Programs.

North Street Bridge - The decking structure dates to the 1970's while the stone abutments are much older. The CT DOT has documented several * deficiencies mostly relating to the stone abutments.

Funding Schedule

| | FY21 | FY22 | FY23 | FY24 | FY25 | TOTAL |
|-----------------|------|---------|------|-----------|------|-----------|
| Bond Funds (2) | - | 400,000 | - | 1,850,000 | - | 2,250,000 |
| Grant Funds (4) | - | 400,000 | - | 1,850,000 | - | 2,250,000 |
| TOTAL | - | 800,000 | - | 3,700,000 | - | 4,500,000 |

TOWN OF KILLINGLY CAPITAL BUDGET

PUBLIC BUILDINGS

Funding Summary

| Funding Source | FY 2021 - 2025 | | | | | Total |
|--|----------------|------------|------------|-----------|------|------------|
| | FY21 | FY22 | FY23 | FY24 | FY25 | |
| Town Hall Building Improvements | (2) | - | 50,000 | - | - | 50,000 |
| Community Center | (2) | 22,000,000 | - | - | - | 22,000,000 |
| Town Hall Elevator | (2) | 800,000 | - | - | - | 800,000 |
| Town Hall 3rd & 4th Floor Renovation/Expansion | (2) | - | 200,000 | 3,000,000 | - | 3,200,000 |
| Public Works Garage Doors | (3) | 100,000 | - | - | - | 100,000 |
| Bugbee Building Improvements | (3) | 50,000 | - | - | - | 50,000 |
| Town Hall Parking Lot Improvements | (3) | - | 150,000 | - | - | 150,000 |
| Public Works Garage Floor and Mechanics Pit | (3) | - | - | 100,000 | - | 100,000 |
| Vehicle Wash Bay | (2) | - | 800,000 | - | - | 800,000 |
| Totals | | 150,000 | 23,950,000 | 3,150,000 | - | 27,250,000 |

Project Comments

- * Town Hall Building Improvements - The first floor main hallway floor is in need of replacement. There are numerous cracks and broken tiles in the hallway areas.
- * Community Center - The existing Community Center is in need of repair and rehabilitation. The current state of disrepair does not provide adequate usable space to meet the needs of the recreation programs. This project would include a complete renovation or in order to restore and reconfigure the building to a proper functional capacity.
- * Town Hall Elevator - The Elevator project would replace the existing elevator and extend service to the 3rd and 4th floors of the Town Hall. The existing elevator was installed in the mid-1980's and requires modifications to meet current code and ADA compliance.
- * Town Hall 3rd & 4th Floor Renovation/Expansion - The space on the 3rd and 4th floors of the Town Hall would provide much needed office space for several departments. This project would include the design, renovation and reconfiguration of office space to allow for a more functional layout among Town Hall departments.
- * Public Works Garage Doors - The garage doors of the Public Works facility are nearing the end of their useful life. The doors and the automatic opening systems are in need of replacement.
- * Bugbee Building Improvements - This project would make improvements to the Bugbee Building to include brick repointing of the building's exterior walls and address issues involving water infiltration.
- * Town Hall Gutter and Parking Lot Improvements - This project would repave the Town Hall Parking lot to improve overall parking lot and walkway safety conditions.
- * Public Works Garage Floor and Mechanics Pit - The project would also include grinding and resealing of the entire garage floor. This would help protect the floor from the salt and make it easier to clean. The mechanic's pit is in need of repair as the concrete walls are starting to crack and spall. The project would update the pit by repairing the walls, add LED lighting, improve drainage, improve ventilation and install a safer easier to use covering system.
- * Vehicle Wash Bay at Highway Garage - The installation of a vehicle wash bay at the Public Works garage would serve the Town and Board of Education vehicle fleet. The project would include a water reclamation system to conserve and reuse water services.

Funding Schedule

| Funding Sources | FY21 | FY22 | FY23 | FY24 | FY25 | TOTAL |
|-----------------|---------|------------|-----------|------|------|------------|
| Bonds (2) | - | 23,800,000 | 3,050,000 | - | - | 26,850,000 |
| LOCP (3) | 150,000 | 150,000 | 100,000 | - | - | 400,000 |
| TOTAL | 150,000 | 23,950,000 | 3,150,000 | - | - | 27,250,000 |

TOWN OF KILLINGLY CAPITAL BUDGET

PARKS AND RECREATION

Funding Summary

| | Funding Source | FY 2021 - 2025 | | | | | Total |
|-------------------------|----------------|----------------|------|------|------|---------|---------|
| | | FY21 | FY22 | FY23 | FY24 | FY25 | |
| Parks at Davis Property | (8) | - | - | - | - | 120,000 | 120,000 |
| Totals | | - | - | - | - | 120,000 | 120,000 |

Project Comments

* Parks at Davis Property- Currently the property is being utilized as a gravel yard. Once this operation has completed the property would be reconstructed to allow for recreational use. The Town would propose to install several playing fields in this location.

Funding Schedule

| | FY21 | FY22 | FY23 | FY24 | FY25 | TOTAL |
|------------------------|------|------|------|------|---------|---------|
| <u>Funding Sources</u> | - | - | - | - | 120,000 | 120,000 |
| Reserve Funds (8) | - | - | - | - | - | - |
| TOTAL | - | - | - | - | 120,000 | 120,000 |

TOWN OF KILLINGLY CAPITAL BUDGET

KILLINGLY SCHOOLS

Funding Summary

| Funding Source | FY 2021 - 2025 | | | | | | Total |
|---|----------------|------------------|----------------|------------------|------------------|-------------------|-------|
| | FY21 | FY22 | FY23 | FY24 | FY25 | | |
| Killingly Westfield Ave Facility | 110,000 | 600,000 | 150,000 | 2,060,000 | 500,000 | 3,420,000 | |
| Killingly Memorial School | - | - | - | - | - | - | |
| Killingly Central School | - | - | 50,000 | 150,000 | 2,000,000 | 2,200,000 | |
| Killingly Intermediate School | - | 1,250,000 | 250,000 | 100,000 | 2,000,000 | 3,600,000 | |
| Killingly High School | - | - | 250,000 | 160,000 | 506,000 | 916,000 | |
| Good-year Early Childhood Learning Center | 25,000 | - | - | - | - | 25,000 | |
| Total | 135,000 | 1,850,000 | 700,000 | 2,470,000 | 5,006,000 | 10,161,000 | |

Project Comments

See Capital Improvement Plan as outlined in the Board of Education Budget.

Funding Schedule

| Funding Sources | FY21 | FY22 | FY23 | FY24 | FY25 | TOTAL |
|----------------------------|----------------|------------------|----------------|------------------|------------------|-------------------|
| Bond Funds (2) | 40,500 | 555,000 | 210,000 | 741,000 | 1,501,800 | 3,048,300 |
| State Education Grants (5) | 94,500 | 1,295,000 | 490,000 | 1,729,000 | 3,504,200 | 7,112,700 |
| TOTAL | 135,000 | 1,850,000 | 700,000 | 2,470,000 | 5,006,000 | 10,161,000 |

TOWN OF KILLINGLY CAPITAL BUDGET

WATER POLLUTION CONTROL AUTHORITY PROJECTS

Funding Summary

| | | FY 2021 - 2025 | | | | | | | | | |
|----------------------------|----------|----------------|----------------|------------------|------------------|------------------|------------------|--|--|--|--|
| | | FY21 | FY22 | FY23 | FY24 | FY25 | Total | | | | |
| Sewer Replacement | Fund 210 | 100,000 | 450,000 | 450,000 | - | - | 1,000,000 | | | | |
| Capital Projects/Equipment | Fund 210 | 304,000 | - | 1,000,000 | 1,000,000 | 1,000,000 | 3,304,000 | | | | |
| Total | | 404,000 | 450,000 | 1,450,000 | 1,000,000 | 1,000,000 | 4,304,000 | | | | |

Project Comments

- * Sewer Line Replacement - This is to fund deficient sewer lines and to correct inflow and infiltration problems and will also identify the problem areas and begin a systematic program that will correct identified deficiencies.
- * Plant Capital Projects- This is to fund building improvements, continued work on pump stations and various equipment not covered by the current Facility Upgrade.

Funding Schedule

| Funding Sources | FY21 | FY22 | FY23 | FY24 | FY25 | TOTAL |
|------------------------|-------------|-------------|-------------|-------------|-------------|--------------|
| Sewer Fund (Fund 210) | 404,000 | 450,000 | 1,450,000 | 1,000,000 | 1,000,000 | 4,304,000 |
| TOTAL | 404,000 | 450,000 | 1,450,000 | 1,000,000 | 1,000,000 | 4,304,000 |

MINUTES

1. workshop - FEB 18, 2020
2. MEETING - FEB 18, 2020



RECEIVED
TOWN CLERK, KILLINGLY, CT

2020 FEB 25 AM 10:07

TOWN OF KILLINGLY, CT

PLANNING AND ZONING COMMISSION

TUESDAY – FEBRUARY 18, 2020

Elizabeth M. Wilson

SPECIAL WORKSHOP MEETING

6:00 PM

Town Meeting Room, Second Floor

Killingly Town Hall

172 Main St., Killingly

MINUTES

- I. **CALL TO ORDER** – Chair, Keith Thurlow called the meeting to order at 6:04 pm.
ROLL CALL – Brian Card, Virge Lorents, Sheila Roddy, Milburn Stone, John Sarantopoulos, Keith Thurlow. Matthew Wendorf was absent with notice.
Staff Present – Jonathan Blake, Planner/Zoning Enforcement Officer.
- II. **SEATING OF ALTERNATES** – None.
- III. **CITIZENS' COMMENTS ON ITEMS NOT SUBJECT TO PUBLIC HEARING** (Individual presentations not to exceed 3 minutes; limited to an aggregate of 21 minutes unless otherwise indicated by a majority vote of the Commission) – None.
- IV. **COMMISSION/STAFF RESPONSES TO CITIZENS' COMMENTS** – None.
- V. **PROPOSED Zone (TEXT) Change Application #19-1221; Town of Killingly; Planning Zoning Commission; RE: Section 530; Off Street Parking and Loading; revision thereto.**
*** Review/Discussion/Action***

Jonathan Blake gave an overview of what had previously been discussed regarding changing the off-street parking requirements due to complaints received from developers and citizens regarding excessive parking spaces in some areas. Mr. Blake took a more pragmatic/commonsense approach when developing the proposed draft language for Section 530, to deal with lessening or removing the off-street parking requirements for developments, as had been discussed at the last workshop. It would be a case-by-case approach.

The Commission Members reviewed the draft language for Section 530 (dated February 18, 2020). A copy had been provided to the Town Attorney, for review.

Draft language proposed for Section 530 (a thru c) is currently being reviewed by Town Engineer, David Capacchione. Ms. Roddy suggested that revision dates be included for documents that are referenced.

There was discussion regarding E-Commerce parking. Mr. Blake will research and incorporate, if needed.

New language proposed for Section 530.2 was reviewed (Table, with proposed changes, was kept as a guideline) which would be more for small businesses who can't afford an engineer or are looking at re-occupation. Not

eliminating the requirement but giving an avenue for development and trying to be open-minded to new types of development. The Town Engineer is always asked for his comments. Mr. Thurlow expressed concern regarding possibly not having enough parking during peak times/shift changes.

There was discussion regarding dimensions in Section 530.4.2 on page 4 of the draft. Mr. Thurlow suggested that numbers be added, for compliance. There was discussion regarding one space per unit for public elderly housing, however, if there is good reasoning for something different and the majority of the PZC agrees, it would be acceptable under these regulations. There was discussion regarding reduction in spaces for retail which may result in space for new development or public space.

There was discussion regarding charging stations/mass-transit. There was discussion regarding bus stops at the Killingly Industrial Park which would be in line with the POCD. Mr. Blake will work on draft language for charging stations (he suggested offering an incentive for developers).

- Ms. Lorents feels that regulations should be visionary as well as for what is needed now.
- Ms. Roddy agreed with Ms. Lorents.
- Mr. Card likes the draft language presented. He does not feel that charging stations should be mandatory. He feels that bus stations would be part of site development review rather than off-street parking.
- Mr. Stone suggested that there be a list of what the PZC wants applicants to specifically address regarding parking (if the guidelines are not used). Ways to address future changes such as charging stations, increased public transportation, bicycle parking.
- Mr. Sarantopoulos suggested waiting to see what the federal government does regarding charging stations and be ready to adopt regulations within the community to keep up with the changing trend in transportation.

Mr. Blake will also investigate the prohibitive parking section in the regulations to see if any language needs to be changed or added.

Commission Members will e-mail comments to Ann-Marie Aubrey.

VI. BEGINNING DISCUSSIONS REGARDING MS4 – Municipal Separate Storm Sewer System

What is it? Why do we have to do it? What role does the PZC have in all of this?

Review/Discussion/Action

Mr. Blake explained that MS4 is mandated by the State to be incorporated into the Regulations. There is a draft regulation ordinance with the Town Attorney for review regarding addressing any types of illicit discharge. Part of MS4 is reducing permeable coverage.

VII. ADJOURNMENT

Motion was made by Brian Card to adjourn at 6:51 p.m. Second by Virge Lorents. Motion carried unanimously (5-0-0).

Respectfully submitted,

J.S. Perreault
Recording Clerk



TOWN OF KILLINGLY, CT
PLANNING AND ZONING COMMISSION
TUESDAY – FEBRUARY 18, 2020

RECEIVED
TOWN CLERK, KILLINGLY, CT
FEB 25 AM 10:07

Regular Meeting
7:00 PM

Elizabeth M. Wilson

Town Meeting Room, Second Floor
Killingly Town Hall
172 Main St., Killingly

MINUTES

I. **CALL TO ORDER** – Chair, Keith Thurlow, called the meeting to order at 7:04 pm.

ROLL CALL – Brian Card, Virge Lorents, Sheila Roddy, Milburn Stone, John Sarantopoulos, Keith Thurlow. Matthew Wendorf was absent with notice.

Staff Present – Ann-Marie Aubrey, Director of Planning and Development; Jonathan Blake, Planner/Zoning Enforcement Officer; Elsie Bisset, Economic Development Director. Mary T. Calorio, Town Manager, was seated in the audience.

II. **SEATING OF ALTERNATES** – None.

III. **AGENDA ADDENDUM** – None.

IV. **CITIZENS' COMMENTS ON ITEMS NOT SUBJECT TO PUBLIC HEARING** (Individual presentations not to exceed 3 minutes; limited to an aggregate of 21 minutes unless otherwise indicated by a majority vote of the Commission)

Johnathan Shatzman, 95 Bailey Hill Road, commented regarding a 14-lot, residential subdivision that he had received PZC approval for eleven years ago. Open space, behind the 14 lots, was to be used for an equestrian trail and nature walk. Mr. Shatzman explained that he had planned for the 14 homeowners to be members of a condominium association with rights to use the open space area. However, there is no interest in a condominium association/leases. There is more interest in homeowners' associations or timeshares. He asked if he is entitled to sell the 14 lots individually and keep the equestrian trail for himself, or does he have to give access to the trail to the 14 lots?

V. **COMMISSION/STAFF RESPONSES TO CITIZENS' COMMENTS**

Motion was made by Virge Lorents to add to the agenda, Item X. OTHER / MISCELLANEOUS. 2) Discussion regarding a previously approved 14-lot, condominium subdivision (Johnathan Shatzman), to the agenda. Second by Milburn Stone. No discussion. Motion carried unanimously (5-0-0).

VI. **PUBLIC HEARINGS – (review / discussion / action)**

1) Plan of Conservation and Development (POCD) – The Commission has completed its review and re-write of the Town's Plan of Conservation and Development as required under State Statute. New Plan will cover 2020-2030; and if passed the effective date will be Monday, May 4th, 2020 at 12:01 am.

Ann-Marie Aubrey stated that she had received comments from a member of the public.

Ms. Aubrey stated the following for the record:

- Town Council received their copies of the Draft in November and December 2019;
- NECCOG received their copy of the Draft in November 2019;
- A copy of the Draft was posted to the Town's website;

- Copies of the Draft were available for public viewing in the Planning & Development Office and in the Town Clerk's Office, Public Library, and the Killingly Community Center;
- Advertisements were placed in the *Norwich Bulletin*, *Turnpike Buyer*, and *Shoppers' Guide*.
- Minor Comments/Editorial Changes from the Town Council Review:
 - 1) Cover page – change IWWC to IWWA (after Johnathan Blake)
 - 2) Page 5 – last paragraph change “one large dairy farm” to “a cattle farm”
 - 3) Page 7 – first full paragraph, next to last sentence – include “Rogers Corp”
 - 4) Comment from Town Council – please be aware of the areas of conservation (state interest) within the Town – does not want to see “industrial or other commercial development” creep into those areas. Staff did explain that we were looking for more “infill development” – especially in the industrial areas.

Ms. Lorents and Sheila Roddy, as well as Ms. Aubrey, commented that they would like time to review any suggested changes. Ms. Aubrey explained that the public hearing could be continued, and that Ms. Lorents could e-mail her comments to Ms. Aubrey who would, then, forward them to the other PZC Members.

COMMENTS FROM THE PUBLIC:

Donna Bronwell, 699 Bailey Hill Road, almost 40-year resident and 20-year Member of the Killingly Conservation Commission, referred to her written comments/minor corrections that she had prepared for the Commission Members/Staff. She explained that, due difficulty in getting a quorum, the Conservation Commission had not been able to meet, specifically regarding the POCD, since its last meeting with the PZC.

Ms. Bronwell reviewed her report containing her suggestions for changes which include the following:

- Page 8: Some public events that the Conservation Commission has done could be added to the introduction.
- Pages 12 and 13: Promote acquisition of open space.
- Community Facilities Map (after page 14): Add Old Furnace Park, Old Killingly Pond, and hiking indicators for trails.
- Page 20: Action 3 is a duplicate of Action 2.
- Maps after page 8: Pink circles are DEEP critical habitat areas (Future Land Use Map). She said that the proposed new power plant is within one of the pink circles.
- Page 45: Under Action #2 – Educating the General Public, add a statement regarding coordinating public events with the Last Green Valley and NECCOG to promote more public awareness.
- Page 45: Add Action #3 – To establish and approve the 490 designation for open space. The 490 plan is a tax break to encourage protection for forestry and agriculture. There is an option for towns to include open space (ordinance).
- Page 47: Add Action #3 at the top of the page – Make a concerted effort to protect additional critical farmlands from development.
- Add an Action Item – Accept the Killingly Five Ponds Donation in East Killingly.
- Page 51 – Establish a Killingly Green Team.
- Page 52 – New Action Item under Communications - Enhance Channel 22 postings and publicity.

Ms. Bronwell confirmed that the above suggestions are her own, not from the Conservation Commission as a whole, but she stated that she does not think that the other Commission Members would object.

There was discussion regarding whether the suggested changes would be considered minor or major changes. Ms. Aubrey explained that it is under the PZC's discretion whether to accept any of the recommendations or not. Mr. Blake noted that the date received stamp on Ms. Bronwell's report is incorrect as it was received today, February 18, 2020, not in 2019. Ms. Bronwell to with meet with Staff on, or about, February 20th. Ms. Aubrey will report to the PZC for next month.

Motion was made by Virge Lorents to continue the public hearing for **Plan of Conservation and Development (POCD)** – (The Commission has completed its review and re-write of the Town's Plan of Conservation and Development as required under State Statute. New Plan will cover 2020-2030; and if passed the effective date will be Monday, May 4th, 2020 at 12:01 a.m.), to the next regularly scheduled meeting of the Killingly Planning and Zoning Commission on Monday, March 16, 2020, Town Meeting Room, Second Floor, Killingly Town Hall, 172 Main Street, at 7:00 p.m.

Discussion:

Comments from Commission Members:

- Sheila Roddy stated that she is okay with making the editorial comments now so that the Commission can just focus on the more significant actions.
- Brian Card commented that the inclusion of additional action items may be above and beyond what was public noticed. He suggested that as the Commission reviews the action items, see where editorial changes can be made in existing action items to try to incorporate the intent of the new action item. So, it would be more of an editorial change as opposed to adding new action items into the Document.

Second by Milburn Stone. Motion carried unanimously (5-0-0).

VII. UNFINISHED BUSINESS – (review / discussion / action)

1) Plan of Conservation and Development (POCD) – The Commission has completed its review and re-write of the Town's Plan of Conservation and Development as required under State Statute. New Plan will cover 2020-2030; and if passed the effective date will be Monday, May 4th, 2020 at 12:01 am. – Continued (see above).

VIII. NEW BUSINESS – (review/discussion/action)

1) **Special Permit Application #20-1233** – Rene Bernier (Pine Hill Farm, LLC /landowner); conversion of an existing chicken coop into a storage facility; 204 Hartford Pike; GIS MAP 108, Lot 34, ~5.0 acres; Low Density. Article VII, Section 700 etc., Special Permits; Section 410.2.2.o Proposed Adaptive Re-Use of an Agricultural Building (Low Density). **Receive and if application is complete schedule for a public hearing. The next available hearing date is March 16, 2020; will allow enough time for proper legal notice.**

Ms. Aubrey stated that the Application appears to be complete at this time.

Motion was made by Brian Card to receive and schedule a public hearing for **Special Permit Application #20-1233** – Rene Bernier (Pine Hill Farm, LLC /landowner); conversion of an existing chicken coop into a storage facility; 204 Hartford Pike; GIS MAP 108, Lot 34, ~5.0 acres; Low Density. Article VII, Section 700 etc., Special Permits; Section 410.2.2.o Proposed Adaptive Re-Use of an Agricultural Building (Low Density), for the next regularly scheduled meeting of the Killingly Planning and Zoning Commission on Monday, March 16, 2020, Town Meeting Room, Second Floor, Killingly Town Hall, 172 Main Street, at 7:00 p.m. No discussion. Second by Virge Lorents. Motion carried unanimously (5-0-0).

2) **Site Plan Review Application #20-1234** – Nabil Roufaz (MSDC Realty Trust/landowner); re-establishment (renovation) of the strip mall located at 544 Main Street; GIS MAP 175, Lot 10, ~1.0 acre; Village Commercial. **The mall is pre-existing, there is no change to the structure, this is just a renovation/re-establishment of mall.**

Ms. Aubrey explained that this is a renovation to the exterior and that there are some interiors that are empty right now, so new people will be coming in.

Exterior renovations:

- Parking lot
- Making sure that they meet handicap requirements
- Realigning the parking lot
- Building itself will not change, except for different signs when new tenants come in
- Entrance and exiting to the road will stay the same

Motion was made by Brian Card to allow Staff to review **Site Plan Review Application #20-1234** – Nabil Roufaz (MSDC Realty Trust/landowner); re-establishment (renovation) of the strip mall located at 544 Main Street; GIS MAP 175, Lot 10, ~1.0 acre; Village Commercial. **The mall is pre-existing, there is no change to the structure, this is just a renovation/re-establishment of mall.** Second by Virge Lorents. No discussion. Motion carried unanimously (5-0-0).

3) **§8-24 Review Application #20-1235** – Town of Killingly; Killingly Memorial School; removal of modular classrooms and replace with a new school wing and library; 339 Main Street; GIS MAP 181, Lot 142; ~10.5 acres; Boro Res High.

Copies of the presentation, to the Town Council, by Silver/Petrucci & Associates were included in packets to Commission Members.

Town Manager, Mary T. Calorio explained that the new wing would be a permanent structure which would replace all the needed classroom space that is currently being housed within the modular classrooms (from 1971 and 2003 – each with a lifespan of 8-10 years). It is estimated to be an 18-month project. Ms. Calorio explained the timeline. The Superintendent has evaluated the impacts on the school and students. Students will not have access to the construction area or see or hear any of the construction activity, so there will be no impact on the students. The plan also includes reconfiguration of parking to alleviate some of the congestion around the traffic light on Route 12. It gives a different exit point for the buses. It also gives a longer on-premises line for parent drop-off.

Motion was made by Brian Card to support the **58-24 Review Application #20-1235** – Town of Killingly; Killingly Memorial School; removal of modular classrooms and replace with a new school wing and library; 339 Main Street; GIS MAP 181, Lot 142; ~10.5 acres; Boro Res High. Second by Virge Lorents. No discussion. Motion carried unanimously (5-0-0).

- 4) **58-24 Review Application #20-1236** – Town of Killingly; Killingly Community Center Relocation; 79 Westfield Avenue, GIS MAP 176, Lot 9, ~17 Acres; Boro Res High.

Copies of the presentation, to the Town Council, by Silver/Petrucci & Associates were included in packets to Commission Members.

Town Manager, Mary T. Calorio explained that the Town Council has looked at several alternatives. The existing building poses several challenges and would require a heavy infrastructure investment. The Westfield Avenue building was evaluated, and they would be utilizing the Vo-Ag wing, the rear wing, and the Auditorium wing for the Community Center space. The Board of Education Central Offices and Eastconn's program would still remain located at this facility. Security mechanisms needed to maintain each program's security were evaluated. Veterans' Coffeehouse would be co-shared with Recreation in the Cafeteria. The gymnasium would be maintained as a shared space (Eastconn uses it during the school day until 2 p.m.). The High School and Recreation wrestling programs now located in the Cafeteria have been relocated near the weight room.

The evaluation showed that the following have been identified as needed work at the Westfield Avenue building even if the Community Center were not located there: roof; brick veneer; windows; HVAC components/heating system. It is felt that relocating the Community Center to Westfield Avenue is the best utilization of Town assets.

The main entrance, in the Vo-Ag area, would be renovated. All renovations for the Community Center portion are interior. The interior, where the Vo-Ag Center is now located, would be the Recreation main office as well as staff offices and some programming space, RSVP (which now utilizes space at the current Recreation Center). Down the hall, where the science classrooms were, would be converted into classroom and program space. The Community Store, currently in the band and music rooms, would be located to the other side of the theatre. The theatre, band and music rooms would be converted into makeup/dressings rooms to support the theatre.

There is no expansion or addition to the building. The other exterior modification is on the parking lot on the Vo-Ag side. The parking lot would be expanded using existing green space to add additional necessary parking, to make the driveway appropriately sized for two vehicles to pass, and to add additional lighting.

Once the current Community Center building is vacated, the Town would dispose of the building, getting the property back on the tax rolls. Ms. Calorio explained that, although there is a deed restriction, there is a reverter clause on it, so the Town could still dispose of the property.

Motion was made by Brian Card to support the **58-24 Review Application #20-1236** – Town of Killingly; Killingly Community Center Relocation; 79 Westfield Avenue, GIS MAP 176, Lot 9, ~17 Acres; Boro Res High. Second by Milburn Stone. No discussion. Motion carried unanimously (5-0-0).

- 5) **Site Plan Review Application #20-1237** – Dandeneau Properties, LLC; proposed building addition and parking lot; 40 Louisa Viens Drive; GIS MAP 57, Lot 12, ~8.7 acres; Industrial Zone. **Receive, and if application is complete, schedule for the next regularly scheduled meeting of Monday, March 16, 2020 for review and action. DOES NOT require a public hearing.**

Keith Thurlow recused himself, turned the Chair Position over to Brian Card and he left the room.

Mr. Card announced that Alternate Member, John Sarantopoulos would be seated as a Voting Member for this Agenda Item.

The Application is complete. There was no discussion.

Motion was made by Virge Lorents to receive and schedule, for review and action, **Site Plan Review Application #20-1237** – Dandeneau Properties, LLC; proposed building addition and parking lot; 40 Louisa Viens Drive; GIS MAP 57, Lot 12, ~8.7 acres; Industrial Zone, for the next regularly scheduled meeting of the Killingly Planning and Zoning Commission on Monday, March 16, 2020, Town Meeting Room, Second Floor, Killingly Town Hall, 172 Main Street, at 7:00 p.m. Second by Milburn Stone. No discussion. Motion carried (5-0-0). Keith Thurlow had recused himself.

Bruce Woodis, KWP Associates, who was seated in the audience, asked if the Commission would like a brief overview of the project. Mr. Card stated that the Site Plan Review was scheduled for the March 16, 2020 meeting.

Mr. Thurlow returned and resumed the position of Chair.

IX. ADOPTION OF MINUTES – (review/discussion/action)

- 1) Special Workshop Meeting of Tuesday, January 21, 2020
- 2) Regular Meeting of Tuesday, January 21, 2020

Motion was made by Virge Lorents to approve the Minutes of the Special Workshop Meeting of Tuesday, January 21, 2020, and the Minutes of the Regular Meeting of Tuesday, January 21, 2020. Second by Brian Card. No discussion. Motion carried unanimously (5-0-0).

X. OTHER / MISCELLANEOUS – (review/discussion/action)

- 1) **Subdivision (Issue) Application # 19-1228**; Anthony J & Josephine A Pulcinella, Trustees; determination of unapproved subdivision 10/21/2019; 309 & 333 Breakneck Hill Road; GIS MAP 65; Lot 7; (a/k/a “Fourth Parcel – first and second tracts”); Rural Development Zone. **Re-establishment of original parcel, and request for “first/free split”. Referred to Town’s Legal Counsel for their opinion.**

Ann-Marie Aubrey gave an update:

- Staff met with the Town’s legal counsel earlier in the day regarding this matter.
- The Town Attorney has concerns with the title regarding how the parcels were supposedly merged back together. (Deeds were created/recorded after Mr. Pulcinella’s last meeting with the PZC where it was found that the subdivision was unapproved).
- A letter will be sent to Mr. Pulcinella explaining the issues/concerns. If Mr. Pulcinella has questions, he will contact the Town Attorney directly. Ms. Aubrey will provide copies of the letter to the Commission Members.
- As far as Staff knows, Mr. Pulcinella does not have an Attorney representing him in this matter. Ms. Lorents urged that Mr. Pulcinella get an attorney. Ms. Aubrey explained that it will be suggested in the letter that Mr. Pulcinella get legal counsel of his own.

No action was taken by the Planning and Zoning Commission.

2) Discussion regarding a previously approved 14-lot, condominium subdivision (Johnathan Shatzman).

Mr. Thurlow stated that this subdivision had been approved under a different set of Regulations no longer in effect (Flex Development).

Johnathan Shatzman stated that 14 lots had been created each with its own legal description (Assessor’s Map). He explained that there is no interest in having an association where people would have to put money into it in order to benefit from it. He said that he is willing to own it, pay taxes on it, and give each of the 14 lots an easement or a limited license so that they can use it without having to be part of an association. He said that they could opt out if they don’t want to use it.

Mr. Thurlow recalls that the only restriction was whatever the requirement was for the open space for that particular type of subdivision. He said that there was no issue at the time because Mr. Shatzman was looking at the whole thing as being a shared condominium which sounded creative at the time. Mr. Thurlow suggested that legal counsel be consulted. Ms. Aubrey commented that the only issue would be that if Mr. Shatzman is maintaining the open space, if it is to be preserved in perpetuity as open space, a conservation easement should be put in place and who would handle the conservation easement. On the Map it says proposed open space. Mr. Shatzman stated that a large portion is wetlands and that he had to give a certain amount of acreage for open space, which he did, he just wants the 14 homeowners to be able to use it for recreation. Ms. Aubrey explained that it is a possibility under conservation easement, which she explained is a contract agreement. Mr. Shatzman stated that there is an existing conservation easement (Town of Killingly). Mr. Shatzman was advised to consult with his legal counsel regarding the open space, as Ms. Aubrey had previously advised him to do.

Ms. Aubrey will research to see if there are already conservation easements held by the Town on that property and, if that is the case, Mr. Shatzman would need to negotiate with the Town (Town Manager/Town Attorney) about the possibility of increasing the conservation easement.

There was discussion regarding the fact that one lot is in the process of being sold. The mylars were filed and the approval was filed. They are shown as individual lots. When the lots sell, the deeds could be created including language regarding the conservation easement. Mr. Thurlow stated that he would like it reviewed and approved by the Town's legal counsel. Ms. Aubrey confirmed that if they want to do conservation easements, Mr. Shatzman's legal counsel and the Town's legal counsel would need to negotiate the terms and conditions/deed restrictions.

XI. CORRESPONDENCE – (review/discussion/action)

A. Zoning Enforcement Officer's & Zoning Board of Appeal's Report(s)

Enclosed

B. Inland Wetlands and Watercourses Agent's Report

Enclosed

C. Building Office Report

Enclosed

Ann-Marie Aubrey stated that she had received correspondence earlier in the day from D'amato (Ballouville Road) requesting a 90-day extension which will be on the agenda for next month. She explained that it was received on time (ie. Before the end of the 90-day recording period), but she was not able to get it on the Agenda for tonight's meeting. The current extension expires on March 10, 2020, which can be backed-up to the date (as has been done in the past).

XII. ECONOMIC DEVELOPMENT DIRECTOR REPORT

Elsie Bisset reported:

- The RFQ (Request for Qualifications) for 140 Main Street is due February 26th at 3:00 p.m. The façade is completed.
- The rest of the façades on Main Street are also finished. Owners are signing final paperwork so that liens can be filed (five-year forgivable, deferred-payment loan).
- Ribbon cutting for Threads Consignment Shop on February 20th.
- KBA Mixer will be held on February 20th at Threads Consignment Shop.
- Ms. Bisset will be retiring at the end of March.

XIII. TOWN COUNCIL LIAISON REPORT – No representation.

XIV. ADJOURNMENT

Motion was made by Milburn Stone to adjourn at 8:05 p.m. Second by Virge Lorents. Motion carried unanimously (5-0-0).

Respectfully submitted,

J.S. Perreault
Recording Clerk

MISC. BUSINESS

1. SUBDIVISION Appl. 19-1213
REQUEST TO EXTEND TIME.

HELLER, HELLER & McCOY
Attorneys at Law
736 Norwich-New London Turnpike
Uncasville, Connecticut 06382

Sidney F. Heller (1903-1986)
Harry B. Heller
William E. McCoy

Telephone: (860)-848-1248
Facsimile: (860)-848-4003

Mary Gagne O'Donal

February 18, 2020

Town of Killingly Planning and Zoning Commission
Attn: Mrs. Ann-Marie L. Aubrey, Director of Planning and Development
172 Main Street
Killingly, CT 06239

RECEIVED
FEB 18 2020

PLANNING & ZONING DEPT.
TOWN OF KILLINGLY

Re: John C. D'Amato, Jr. and Ballouville Road, LLC
Ballouville Road Subdivision

Dear Ann-Marie:

On October 28, 2019, I forwarded to you compliance documents for review which were intended to satisfy the conditions of approval of the Ballouville Road subdivision. At that time, I also requested an extension of the ninety day period within which to file the endorsed mylars in the Killingly, Connecticut Land Records. A ninety day extension was granted by the Killingly Planning and Zoning Commission at its meeting of November 18, 2019.

To date, we have not been advised as to whether or not the revised plans and documents satisfy the conditions of approval enunciated by the Killingly Planning and Zoning Commission.

The current terminal date for filing the mylars is March 4, 2020. I am therefore requesting that the Killingly Planning and Zoning Commission, at its regularly scheduled meeting of February 18, 2020, consider a second extension request and grant another ninety day extension of the statutory time period for filing in order to enable Killingly's staff to review the compliance documents which have been submitted to determine that they comply with the Commission's conditions of approval.

Should you have any questions concerning this request, please feel free to call me.

Very truly yours,

Harry B. Heller

HBH/tlk

Diane Guertin

From: HELLER HELLER MCCOY <hellermccoy@sbcglobal.net>
Sent: Tuesday, February 18, 2020 3:53 PM
To: Diane Guertin; Diane Guertin
Subject: Ballouville Road subdivision
Attachments: Ballouville.pdf

Good afternoon, Diane.

As discussed, I forward herewith a second extension request of the statutory time period for the filing of the mylar maps with respect to the Ballouville Road subdivision which I request that the Killingly Planning and Zoning Commission consider at this evening's meeting. If there is any push back from the Commission, I also forward herewith a email from Ann-Marie indicating that the review would be completed by December 6, 2019. As of this date, I have not been informed as to whether or not the compliance documents which we have submitted on behalf of our clients for review and approval have been approved.

I appreciate your assistance in this matter.

Harry B. Heller

Heller, Heller & McCoy
736 Norwich-New London Turnpike
Uncasville, CT 06382
Telephone: (860) 848-1248
Facsimile: (860) 848-4003

RECEIVED

FEB 18 2020

PLANNING & ZONING DEPT.
TOWN OF KILLINGLY

REPORTS AND
CORRESPONDANCE



TOWN OF KILLINGLY

PLANNING & DEVELOPMENT OFFICE
172 Main Street, Killingly, CT 06239
Tel: 860 779-5311 Fax: 860 779-5381

P&Z – Zoning Enforcement Officer February 2020 Report

ZONING

- 10 Zoning Permit Applications
- 7 Site Inspections (Not including periodic inspections)
- 1 ZBA Applications
- 3 Zoning Letters of Compliance
- 0 Notice of Violation / Request for Compliance Sent
- 0 Cease & Desist Order Letter Sent
- 1 Complaint Assigned to ZEO in February

IWWC

- 3 IWWC Applications Received
- 0 Notice of Violation / Request for Compliance Sent
- 0 Cease & Desist Order Letter Sent

ZONING BOARD OF APPEALS – RECAP

Zoning Board of Appeals meeting on meeting on March 12, 2020 was canceled due to lack of quorum.

INLAND WETLANDS AND WATERCOURSES COMMISSION – RECAP

Inland Wetlands and Watercourses Commissions took the following actions on March 2, 2020.

Application #20-1482 of Patriot Homes LLC for a 30 lot subdivision; with associated grading, drainage, & utilities, within 200'; new roadway and storm water basin within the 200' upland review area; Located at 215 Hartford Pike; GIS Map 108; Lot 4; 20.761 acres; Low Density Zone. **CONTINUED TO APRIL 6TH MEETING WITHOUT A SITE WALK.**

Application #20-1483 of Charles Myers for a single-family home; with associated grading, drainage, utilities and septic and driveway within 200' foot upland review area; Located at 1526 Hartford Pike; GIS Map 99; Lot 2.2; 3.55 acres; Rural Development Zone. **TABLED TO APRIL 6TH MEETING WITHOUT A SITE WALK.**

Application #20-1485 of Raymond Preece for a single-family home (first split) ; with associated grading, drainage, utilities and septic and driveway within 200' foot upland review area; with 150' of wetlands disturbance; Located at 126 Ballouville Road; GIS Map 54; Lot 2.1; 2.1 acres; Low Density Zone. **TABLED TO APRIL 6TH MEETING WITHOUT A SITE WALK.**

INLAND WETLANDS AND WATERCOURSES AUTHORIZED AGENT – RECAP

Inland Wetlands and Watercourses Authorized Agent took the following actions on February 10, 2020.

Application #20-1481 Leonard Zadora for a single-family home; with associated grading, drainage, & utilities, within 200' foot upland review area; Located at 128 Laurel Drive; GIS Map 156; Lot 71; 0.59 acres; Low Density Zone. **APPROVED WITH CONDITIONS.**

PLANNING AND ZONING COMMISSION PLACARDS

All placards have been inspected as required in Section 730 (Town of Killingly Zoning Regulations) and Article III Section 6 (Town of Killingly Subdivision Regulations). All required posting were visible from each boarding street at least ten (10) days prior to the public hearing (Monday, March 16, 2020).

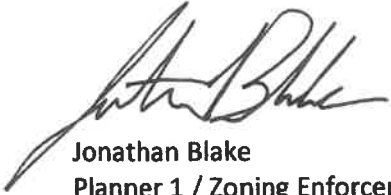
A handwritten signature in black ink, appearing to read 'Jonathan Blake', written in a cursive style.

Jonathan Blake
Planner 1 / Zoning Enforcement Officer
Acting Wetlands Enforcement Agent



TOWN OF KILLINGLY
OFFICE OF BUILDING INSPECTION

MONTHLY PERMIT & FINANCIAL REPORT
FEBRUARY 2020

*****Please note that totals of the reports are not the same because the *Permit Report By Type* includes applications that were paid for in the prior month but were not approved as permits until the current month.**

Town Of Killingly

Paid Fees Report

From: 2/1/2020 To: 2/29/2020

| Payment Date | Identifier | Fee Type | Payer | Payment Type | Payment # | Fee Amount |
|--------------------------------|------------|-------------------------|--------------------------------|--------------|-----------|---------------|
| FeeGroup: Building | | | | | | |
| <i>Payment Type: Cash</i> | | | | | | |
| 2/4/2020 | 000205 | Open Burning Permit | Barber Howard E Darlene M | Cash | 00008271 | 5.00 |
| 1050 HARTFORD PIKE, Killingly | | | | | | |
| 2/4/2020 | 001594 | Res: Roof/Siding/Window | Tracy Bragg | Cash | 00008275 | 35.00 |
| 189 KELLY RD, Killingly | | | | | | |
| 2/7/2020 | | Res: Finished Basement | Done Once Done Right Home Impr | Cash | 00008278 | 35.00 |
| 69 Brookside Drive, Dayville | | | | | | |
| 2/7/2020 | 004394 | Demolition | Desmarais & Sons Inc | Cash | 00008281 | 35.00 |
| 400 HARTFORD PIKE, Killingly | | | | | | |
| 2/12/2020 | 005855 | Res: Mechanical | Diana Connolly | Cash | 00008297 | 35.00 |
| 918 PROVIDENCE PIKE, Killingly | | | | | | |
| 2/14/2020 | 002391 | Res: Roof/Siding/Window | John Currier | Cash | 00008307 | 35.00 |
| 332 RIVER RD, Killingly | | | | | | |
| 2/19/2020 | 004391 | Res: Roof/Siding/Window | Right Construction | Cash | 00008343 | 238.00 |
| 1309 HARTFORD PIKE, Killingly | | | | | | |
| 2/19/2020 | 000663 | Retaining Walls | Earth Retention Systems LLC | Cash | 00008342 | 35.00 |
| 166 HALLS HILL RD, Killingly | | | | | | |
| 2/26/2020 | 001361 | Res: Roof/Siding/Window | Dudley Young | Cash | 00008334 | 35.00 |
| 24 ARNOLD LN, Killingly | | | | | | |
| 2/27/2020 | 000972 | Open Burning Permit | Ross Donald L Sr & Brenda E | Cash | 00008337 | 5.00 |
| 340 STATE AV, Killingly | | | | | | |
| Cash Total: | | | | | | 493.00 |

Town Of Killingly
Paid Fees Report

| Payment Date | Identifier | Fee Type | Payer | Payment Type | Payment # | Fee Amount |
|----------------------------|------------|-------------------------|---------------------------------|------------------|-----------|------------|
| <i>Payment Type: Check</i> | | | | | | |
| 2/4/2020 | 004135 | Res: Mechanical | PosiGen | Check #4302 | 00008270 | 296.00 |
| 2/4/2020 | 002428 | Res: Mechanical | Hometown Heating LLC | Check #7104 | 00008272 | 95.00 |
| 2/4/2020 | 003028 | Res: Roof/Siding/Window | The Roofing Store LLC | Check #11170 | 00008273 | 91.00 |
| 2/4/2020 | 003900 | Res: Mechanical | Walter Electric LLC | Check #2842 | 00008276 | 35.00 |
| 2/6/2020 | 002805 | Res: Mechanical | Sunrun, Inc. | Check #231000456 | 00008277 | 237.00 |
| 2/7/2020 | 004589 | Res: Mechanical | Momentum Solar | Check #201807 | 00008282 | 273.00 |
| 2/10/2020 | 004760 | Res: Roof/Siding/Window | Neil Barnett | Check #798 | 00008283 | 35.00 |
| 2/10/2020 | 002598 | Res: Roof/Siding/Window | Jim & Tom Guillot | Check #106 | 00008284 | 350.00 |
| 2/10/2020 | 001959 | Res: Renovations | Chris Fallon | Check #7926 | 00008285 | 420.00 |
| 2/10/2020 | 004177 | Res: Mechanical | Service Station Equipment, Inc. | Check #11352 | 00008287 | 35.00 |
| 2/11/2020 | 006514 | Res: Renovations | Anthony & Joseph Pellecchia | Check #551 | 00008291 | 280.00 |
| 2/11/2020 | 009654 | Commercial Project Cost | Carreto Associates, LLC | Check #1353 | 00008293 | 104.00 |
| 2/11/2020 | 009654 | Commercial Project Cost | Carreto Associates, LLC | Check #1353 | 00008293 | 104.00 |

Town Of Killingly
Paid Fees Report

| Payment Date | Identifier | Fee Type | Payer | Payment Type | Payment # | Fee Amount |
|--|------------|---------------------------|-------------------------------|--------------|-----------|------------|
| 2/12/2020 | 000530 | Commercial Project Cost | Chaffee Industrial Roofing | Check #25672 | 00008298 | 5,035.00 |
| 60 LOUISA VIENS DR, Killingly | | | | | | |
| 2/13/2020 | 710510 | Res: Roof/Siding/Window | RER Associates LLC | Check #18202 | 00008300 | 220.00 |
| 187 LAUREL POINT RD, Killingly | | | | | | |
| 2/13/2020 | 003143 | Res: Renovations | William Larkin | Check #520 | 00008302 | 490.00 |
| 145 COUNTRY CLUB RD, Killingly | | | | | | |
| 2/13/2020 | 009682 | Res: Detached Garage | Kathleen & Glen Bankowski | Check #609 | 00008303 | 406.00 |
| 1133 HARTFORD PIKE, Killingly | | | | | | |
| 2/14/2020 | 001150 | Res: Roof/Siding/Window | Southern NE Windows | Check #20876 | 00008347 | 170.00 |
| 25 WYNDHAM LANDING, Killingly | | | | | | |
| 2/18/2020 | 009159 | Commercial Project Cost | Delmar Electrical Contractors | Check #27089 | 00008308 | 1,600.00 |
| 30 FORBES RD (Rite Aid), Killingly | | | | | | |
| 2/18/2020 | 008917 | Res: One Story/Multi/Town | Leonard Zadora | Check #2812 | 00008310 | 2,157.00 |
| 128 LAUREL DR, Killingly | | | | | | |
| 2/18/2020 | 712891 | Res: Mechanical | DDL C Energy | Check #9493 | 00008313 | 35.00 |
| 221 NO SHORE RD, Killingly | | | | | | |
| 2/18/2020 | 000109 | Commercial Project Cost | Woodstock Building Assoc | Check #5538 | 00008314 | 98.00 |
| 541 HARTFORD PIKE (Dunkin Donuts), Killingly | | | | | | |
| 2/18/2020 | 000980 | Res: Renovations | Rabitor Brad T Dominique L | Check #2812 | 00008315 | 35.00 |
| 99 CHASE RD, Killingly | | | | | | |
| 2/19/2020 | 007553 | Res: One Story/Multi/Town | Jasen & Kelly Cusson-Malone | Check #677 | 00008316 | 2,047.00 |
| 1274 HARTFORD PIKE, Killingly | | | | | | |
| 2/19/2020 | 004276 | Res: Mechanical | Chaput Electric | Check #2757 | 00008318 | 84.00 |
| 39 STEVEN ST, Killingly | | | | | | |
| 2/19/2020 | 005804 | Demolition | Racine & Sons | Check #14425 | 00008319 | 103.00 |
| 2 MILL RD, Killingly | | | | | | |

Town Of Killingly
Paid Fees Report

| Payment Date | Identifier | Fee Type | Payer | Payment Type | Payment # | Fee Amount |
|--|------------|-------------------------|-------------------------|--------------|-----------|----------------------------------|
| 2/20/2020 | 000065 | Commercial Project Cost | John Ryan Company, Inc | Check #44916 | 00008346 | 35.00 |
| 601 HARTFORD PIKE (Taco Bell), Killingly | | | | | | |
| 2/20/2020 | 009150 | Res: Mechanical | LalMountain Bros Inc | Check | 00008321 | 4,400.00 |
| 260 LAKE RD, Killingly | | | | | | |
| 2/24/2020 | 001352 | Commercial Project Cost | Cerreto Associates, LLC | Check #1354 | 00008323 | 256.00 |
| 150 WARE RD (Westview Nursing), Killingly | | | | | | |
| 2/24/2020 | 712891 | Res: Mechanical | Cartier Electric, LLC | Check #1054 | 00008327 | 35.00 |
| 221 NO SHORE RD, Killingly | | | | | | |
| 2/25/2020 | 009079 | Res: Mechanical | Derek Stone | Check #127 | 00008328 | 35.00 |
| 204 WHESTSTONE MILLS, Killingly | | | | | | |
| 2/25/2020 | 001356 | Res: Mechanical | Derek Stone | Check #2103 | 00008329 | 35.00 |
| 74 KILLINGLY DR, Killingly | | | | | | |
| 2/27/2020 | 710589 | Res: Renovations | Mark Tetreault | Check #13631 | 00008335 | 1,708.00 |
| 220 NO SHORE RD, Killingly | | | | | | |
| FeeGroup: Code Compliance / Inspect | | | | | | Check Total: 21,235.00 |
| Payment Type: Cash | | | | | | Building Total: 21,728.00 |
| 2/4/2020 | 003488 | House Code Inspection | John & Tremblay | Cash | 00008274 | 25.00 |
| 39 MECHANIC ST, Killingly | | | | | | |
| Payment Type: Check | | | | | | Cash Total: 25.00 |
| 2/3/2020 | 001520 | House Code Inspection | Desjardin Lucien R Jr | Check #4098 | 00008260 | 25.00 |
| 222 BROAD ST, Killingly | | | | | | |
| 2/3/2020 | 001520 | House Code Inspection | Desjardin Lucien R Jr | Check #4098 | 00008261 | 25.00 |
| 222 BROAD ST, Killingly | | | | | | |

Town Of Killingly

Paid Fees Report

| Payment Date | Identifier | Fee Type | Payer | Payment Type | Payment # | Fee Amount |
|---|------------|---------------------------|----------------------------|--------------|-----------|------------------|
| 2/10/2020 | 005404 | House Code Inspection | Rosalie & Lucien Laliberty | Check #4154 | 000083301 | 25.00 |
| 2/10/2020 | 003191 | House Code Inspection | Mary Latessa | Check #249 | 00008286 | 25.00 |
| 2/26/2020 | 003265 | House Code Inspection | Edmond M Raheb | Check #19860 | 00008331 | 25.00 |
| 2/26/2020 | 003265 | House Code Inspection | Edmond M Raheb | Check #19860 | 00008332 | 25.00 |
| FeeGroup: Liquor | | | | | | |
| <i>Payment Type: Check</i> | | | | | | |
| 2/26/2020 | 002040 | Liquor Permit Renewal/Ann | 460 Hartford Pike LLC | Check #2790 | 00008330 | 50.00 |
| 460 HARTFORD PIKE (Raiside Tavern), Killingly | | | | | | |
| Check Total: | | | | | | 150.00 |
| Code Compliance / Inspect Total: | | | | | | 175.00 |
| Check Total: | | | | | | 50.00 |
| Liquor Total: | | | | | | 50.00 |
| Paid Fees Grand Total: | | | | | | 21,953.00 |

**NOTICE OF TENTATIVE DECISION
INTENT TO ISSUE A STATE PERMIT
FOR THE FOLLOWING DISCHARGE INTO
THE WATERS OF THE STATE OF CONNECTICUT**

TENTATIVE DECISION

The Commissioner of Energy and Environmental Protection ("the Commissioner") hereby gives notice of a tentative decision to issue a permit based on an application submitted by **NTE Connecticut, LLC** ("the applicant") under section 22a-430 of the Connecticut General Statutes ("CGS") for a permit to discharge into the waters of the state.

In accordance with applicable federal and state law, the Commissioner has made a tentative decision that the proposed system to treat the discharge will protect the waters of the state from pollution.

The Commissioner proposes to require the applicant to submit plans and specifications of the proposed treatment system and such additional information as the Commissioner deems necessary to ensure the protection of the waters of the state from pollution. If such plans are approved by the Commissioner and the treatment system is constructed in full compliance with the approval, the Commissioner proposes to issue a permit for this discharge to the sewer.

The proposed permit, if issued by the Commissioner, will require that wastewater be treated and periodically monitored to demonstrate it meets permit effluent limitations.

APPLICANT'S PROPOSAL

NTE Connecticut, LLC proposes to discharge a maximum of 90,000 gallons per day of low volume wastewaters from steam electric power generation operations at the Killingly Energy Center to the Killingly Water Pollution Control Facility.

The name and mailing address of the permit applicant are:

NTE Connecticut, LLC
24 Cathedral Place, Suite 300
Saint Augustine, Florida 32084

RECEIVED

MAR 10 2020

PLANNING & ZONING DEPT.
TOWN OF KILLINGLY

The proposed activity will take place at:

Killingly Energy Center
189 Lake Road
Killingly, Connecticut 06241

REGULATORY CONDITIONS

Type of Treatment

Wastewater from the plant floor drains will be passed through an oil/water separator to remove oil and grit prior to the operational sump (DSN 201-1).

Effluent Limitations

This permit contains effluent limitations and conditions consistent with Case by Case Determination using the criteria of Best Professional Judgement and 40 CFR 423.17(b) Steam Electric Power Generating Point Source Category Pretreatment Standards for New Sources (PSNS) and will protect the waters of the state from pollution when all of the conditions of the permit have been met.

In accordance with section 22a-430-4(l) of the Regulations of Connecticut State Agencies ("RCSA"), the permit contains effluent limitations for temperature, heavy metals and pH.

Compliance Schedule

This permit contains an enforceable compliance schedule which requires the applicant to notify the Commissioner when commercial operations commence, submit an updated operation and maintenance plan for the wastewater treatment system once built, and submit a detailed analytical analysis of the discharge once commercial operations begin.

COMMISSIONER'S AUTHORITY

The Commissioner is authorized to approve or deny such permits pursuant to section 22a-430 of the CGS and the Water Discharge Permit Regulations (section 22a-430-3 and 4 of the RCSA).

INFORMATION REQUESTS

The application has been assigned the following numbers by the Department of Energy and Environmental Protection. Please use these numbers when corresponding with this office regarding this application.

APPLICATION NO. 201615592 PERMIT ID NO. SP0002475

Interested persons may obtain copies of the application from

Tim Eves
NTE Connecticut, LLC
24 Cathedral Place, Suite 300
Saint Augustine, Florida 32084
813-503-2991

The application is available for inspection by contacting Stephen Edwards at the Water Permitting and Enforcement Division, Bureau of Materials Management and Compliance Assurance, Department of Energy and Environmental Protection, 79 Elm Street, Hartford, CT 06106-5127 or at 860 424 3838 from 8:30 - 4:30, Monday through Friday.

Any interested person may request in writing that his or her name be put on a mailing list to receive notice of intent to issue any permit to discharge to the surface waters of the state. Such request may be for the entire state or any geographic area of the state and shall clearly state in writing the name and mailing address of the interested person and the area for which notices are requested.

PUBLIC COMMENT

Prior to making a final decision to approve or deny any application; the Commissioner shall consider written comments on the application from interested persons that are received within thirty (30) days of this public notice. Written comments should be directed to Stephen Edwards, Bureau of Materials Management and Compliance Assurance, Department of Energy and Environmental Protection, 79 Elm Street, Hartford, CT 06106-5127. The Commissioner may hold a public hearing prior to approving or denying an application if in the Commissioner's discretion the public interest will be best served thereby, and shall hold a hearing upon receipt of a petition signed by at least twenty-five (25) persons. Notice of any public hearing shall be published at least thirty (30) days prior to the hearing.

Petitions for a hearing should include the application number noted above and also identify a contact person to receive notifications. Petitions may also identify a person who is authorized to engage in discussions regarding the application and, if resolution is reached, withdraw the petition. Original petitions must be *mailed or delivered* to: DEEP Office of Adjudications, 79 Elm Street, 3rd floor, Hartford, CT, 06106-5127. Petitions cannot be sent by fax or email. Additional information can be found at www.ct.gov/deep/adjudications.

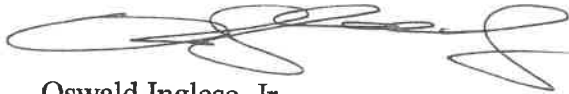

Oswald Inglese, Jr.
Director
Water Permitting and Enforcement Division
Bureau of Materials Management and Compliance Assurance

Dated: *February 28, 2020*

PZC - March, '20

ZONING PRACTICE

FEBRUARY 2020



AMERICAN PLANNING ASSOCIATION

RECEIVED

FEB 18 2019

PLANNING & ZONING DEPT.
TOWN OF KILLINGLY

➔ ISSUE NUMBER 2

PRACTICE PARKING REFORM

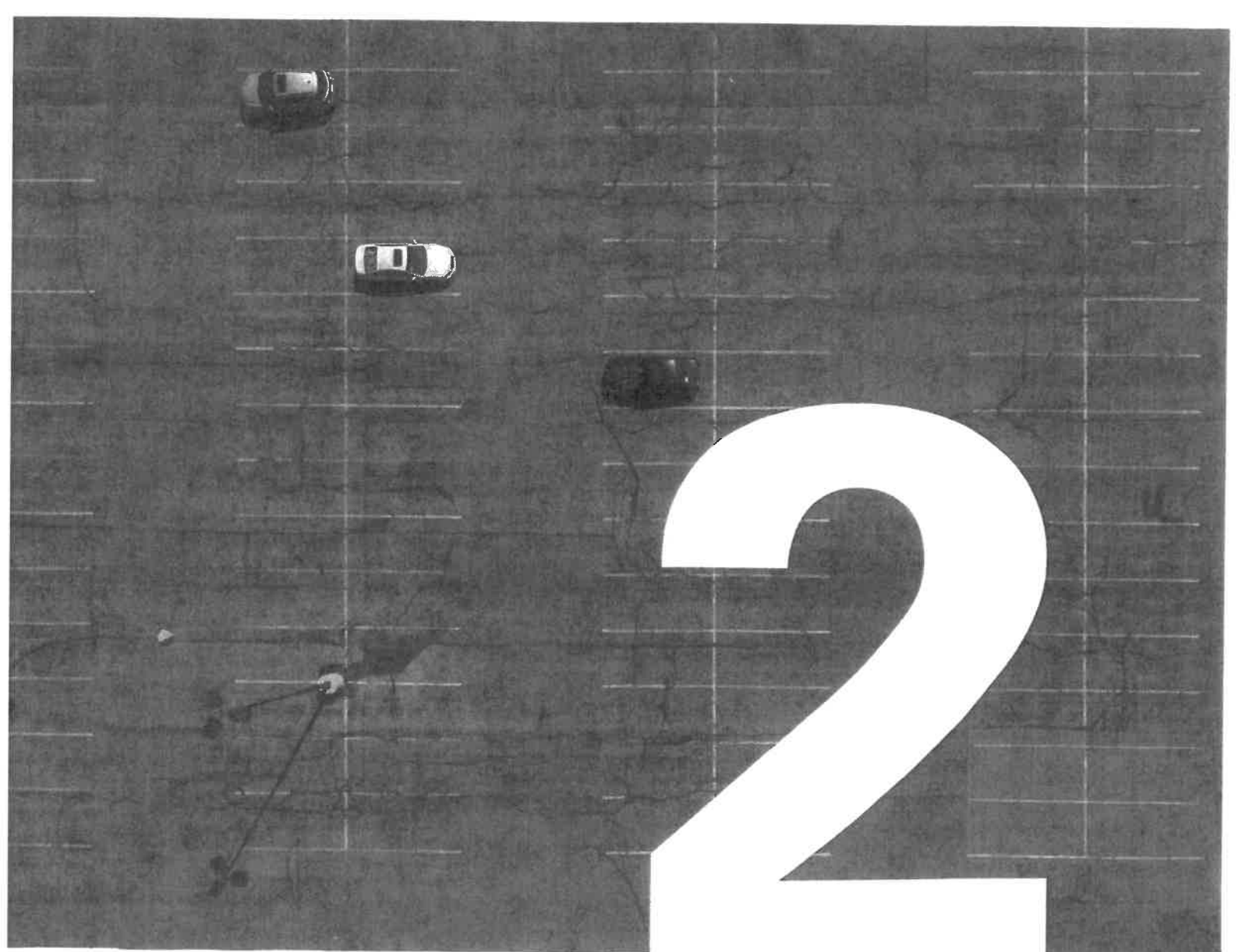

The Pseudoscience of Parking Requirements

Donald Shoup, FAICP

At the dawn of the automobile age, suppose Henry Ford and John D. Rockefeller had asked how city planners could increase the demand for cars and gasoline. Consider three options. First, divide the city into separate zones (housing here, jobs there, shopping somewhere else) to create travel between the zones. Second, limit density to spread everything apart and further increase travel. Third, require ample off-street parking everywhere so cars will be the easiest and cheapest way to travel.

American cities have unwisely adopted these three car-friendly policies. Separated land uses, low density, and ample free parking create drivable cities but prevent walkable neighborhoods. Although city planners did not intend to enrich the automobile and oil industries, their plans have shaped our cities to suit our cars.

Parking requirements are particularly ill-advised because they directly subsidize cars. We drive to one place to do one thing and then to another place to do another thing and then drive a long way back home, parking free everywhere. In *The High Cost of Free Parking*, published by the American Planning Association in 2005, I argued that parking requirements increase traffic congestion, pollute the air, encourage sprawl, raise housing costs, degrade urban design, prevent walkability, damage the economy, and penalize everyone who cannot afford a car. Since then, to my knowledge, no member of the planning profession has argued that parking requirements do not cause these harmful effects. Instead, a flood of recent research has shown that parking requirements are poisoning our cities with too much parking.

Despite all the harm off-street parking requirements cause, they are almost an established religion in zoning practice. One should not criticize anyone else's religion, but I'm a protestant when it comes to parking requirements. And I believe zoning needs a reformation.

THREE PARKING REFORMS

Reform is difficult because parking requirements do not exist without a reason. If

on-street parking is free, removing off-street parking requirements will overcrowd the on-street parking and everyone will complain. Therefore, to distill 800 pages of *The High Cost of Free Parking* into three bullet points, I recommended three parking reforms that can improve cities, the economy, and the environment:

- **Remove off-street parking requirements.** Developers and businesses can then decide how many parking spaces to provide for their customers.
- **Charge the right prices for on-street parking.** The right prices are the lowest prices that will leave one or two open spaces on each block, so there will be no parking shortages. Prices will balance the demand and supply for on-street space.
- **Spend the parking revenue to improve public services on the metered streets.** If everybody sees their meter money at work, the new public services can make demand-based prices for on-street parking politically popular.

Each of these three policies supports the other two. Spending the meter revenue to improve neighborhood public services can create political support to charge the right prices for curb parking. If cities charge the right prices to produce one or two open spaces on every block, no one can say there is a shortage of curb parking. If there is no shortage of curb parking, cities can then remove their off-street parking requirements. Finally, removing off-street parking requirements will increase the demand for curb parking, which will increase the revenue to pay for public services.

THE MOST EMOTIONAL TOPIC IN TRANSPORTATION

Everyone wants to park free, and most people consider parking a personal issue, not a policy problem. Rational people quickly become emotional about parking, and staunch conservatives turn into ardent communists. Thinking about parking seems to take place in the reptilian cortex, the most

primitive part of the brain responsible for snap judgments about urgent fight-or-flight issues, such as how to avoid being eaten. The reptilian cortex is said to govern instinctive behavior like aggression, territoriality, and ritual display, which all play a role in parking.

Parking clouds people's minds, shifting analytic faculties to a lower level. Some strongly support market prices—except for parking. Some strongly oppose subsidies—except for parking. Some abhor planning regulations—except for parking. Some insist on rigorous data collection and statistical tests—except for parking. This parking exceptionalism has impoverished thinking about parking policies, and ample free parking is seen as a goal that planning should produce. If drivers paid the full cost of their parking, it would seem too expensive, so we expect someone else to pay for it. But a city where everyone happily pays for everyone else's free parking is a fool's paradise.

Few people are interested in parking itself, but parking strongly affects issues people do care strongly about, such as affordable housing, climate change, economic development, public transportation, traffic congestion, and urban design. For example, parking requirements reduce the supply and increase the price of housing. Parking subsidies lure people into cars from public transportation, bicycles, or their own two feet. Cruising for free curb parking congests roads, pollutes the air, and adds greenhouse gases. Do people really want a drive-in dystopia more than they want affordable housing, clean air, walkable neighborhoods, good urban design, and a sustainable planet?

Reforms in planning for parking may be the cheapest, quickest, and most politically feasible way to achieve many social, economic, and environmental goals.

THE EFFECTS OF PARKING REQUIREMENTS

Cities have parking requirements for every art gallery, bowling alley, dance hall, fitness club, hardware store, movie theater, night club, pet store, tavern, and zoo without knowing the demand for parking at any of

them. Despite a lack of theory and data, planners set parking requirements for hundreds of land uses in hundreds of cities—the 10,000 commandments of planning for parking. Planners have adopted a veneer of professional language to justify the practice, but planning for parking is learned only on the job and it is more a political activity than a professional skill.

Consider what planners do not know when they set parking requirements:

- How much the required parking spaces cost
- How much drivers are willing to pay for parking
- How parking requirements increase the price of everything except parking
- How parking requirements affect architecture and urban design
- How parking requirements affect travel choices and traffic congestion
- How parking requirements affect air pollution, fuel consumption, and CO₂ emissions

The High Cost of Parking Requirements

Cost is an especially important unknown. A recent study found that the parking spaces required for shopping centers in Los Angeles increase the cost of building a shopping center by 67 percent if the parking is in an aboveground structure and by 93 percent if the parking is underground (Shoup 2014). Retailers pass this high cost on to all shoppers, regardless of how they travel. People who cannot afford a car pay more for their groceries so richer people can park free when they drive to the store.

Without knowing how much the required parking spaces cost to build, planners cannot know how parking requirements increase the cost of housing. Small, spartan apartments cost less to build than large, luxury apartments, but their parking spaces cost the same. Because many cities require the same number of spaces for every apartment regardless of its size or quality, the required parking disproportionately increases the cost of low-income housing. One study found that minimum parking requirements raise housing costs by 13 percent for families without cars (Gabbe and Pierce 2017).

Drivers pay for their cars, fuel, tires, maintenance, repairs, insurance, and



Stuart Cohen, Transform

Figure 1. An office park on the border of Milpitas and San Jose, California.

registration fees, but they usually don't pay for parking. Who does pay for the parking? Everyone, including people who cannot afford a car. All of life's necessities cost more in order to provide free parking.

America is a free country, and many people seem to think that means parking should be free. Parking requirements enable everyone to park free at everyone else's expense, and no one knows that anyone is paying anything. Parking is free, however, only because everything else is more expensive. Parking requirements are well-intentioned, but good intentions do not guarantee good results or mitigate unintended harm.

The required parking takes up a lot of space. Parking lots typically have about 330 square feet per space. Because there are at least three off-street parking spaces per car in the United States, there are at least 990 square feet of off-street parking space per car. In comparison, there are about 800 square feet of housing space per person in the United States. The area of off-street parking per car is thus larger than the area of housing per human.

In astronomy, dark energy is a force that permeates space and causes the universe to expand. Similarly, in urban planning, parking requirements are a force

that causes cities to expand. The higher the parking requirements, the stronger the dark energy that spreads cities out and rips them apart. Typically, the process of setting the parking requirements is closer to astrology than astronomy.

Parking Requirements in Practice

When I am invited to speak in a city, I start with an aerial view of a site in the city with too much parking, such as this photo of an office park in San Jose, California (Figure 1). It looks like a giant parking lot with a few buildings.

I then show a page from the city's parking requirements, which are so precise and so specific for so many land uses that most people probably assume planners carefully study parking (Table 1). Instead, planners are winging it. Planners are not oracles who can divine the demand for parking. I have never met a city planner who could explain why any parking requirement should not be higher or lower. To set parking requirements, planners usually take instructions from elected officials, copy other cities' parking requirements, or rely on unreliable surveys. Parking requirements are closer to sorcery than to science.

Next, I show the size of the parking lots resulting from the city's parking

TABLE 1. SELECT PARKING REQUIREMENTS FOR “ENTERTAINMENT AND RECREATION” USES IN SAN JOSE, CALIFORNIA

| Use | Vehicle Parking Required |
|----------------------------------|---|
| Arcade, amusement game | 1 per 200 sq. ft. of floor area |
| Batting cages | 1 per station, plus 1 per employee |
| Bowling establishment | 7 per lane |
| Driving range | 1 per tee, plus 1 per employee |
| Golf course | 8 per golf hole, plus 1 per employee |
| Health club, gymnasium | 1 per 80 sq. ft. recreational space |
| Miniature golf | 1.25 per tee, plus 1 per employee |
| Performing arts rehearsal space | 1 per 250 sq. ft. of floor area |
| Poolroom/billiards establishment | 1 per 200 sq. ft. of floor area |
| Private club or lodge | 1 per 4 fixed seats on the premises, or 1 per 6 linear feet of seating, plus 1 per 200 square feet of area without seating but designed for meeting or assembly by guests, plus 1 per 500 sq. ft. of outdoor area developed for recreational purposes |
| Recreation, commercial (indoor) | 1 per 80 sq. ft. of recreational area |
| Recreation, commercial (outdoor) | 20 per acre of site |
| Skating rink | 1 per 50 sq. ft. of floor area |
| Swim and tennis club | 1 per 500 sq. ft. of recreation area |

requirements. For many land uses, the parking lots are bigger than the buildings they serve (Figure 2). There is more space for parking than for people. For example, San Jose, California, requires a restaurant to provide a parking lot that is more than eight times the size of the restaurant itself. The requirements provide parking everywhere anyone wants to go, but they also create places where few people want to be.

Most people think parking behaves like a liquid. If the parking supply is squeezed in one place, cars will park somewhere else. But parking behaves more like a gas. The number of cars expands to fill the available space, and more parking leads to more cars. Nevertheless, planners usually assume that cars and people come in fixed proportions, and they often require parking in proportion to people: per beautician, dentist, mechanic, nun, student, teacher, or tennis player. If parking were priced to cover its cost, people would own fewer cars and drive less.

Parking requirements are not only ridiculous but also dangerous. They make cities friendly to cars but not to people—drivable but not walkable. As Jane Jacobs wrote, “The more downtown is broken up and interspersed with parking lots and garages, the

duller and deader it becomes, and there is nothing more repellent than a dead downtown.” We want more out of our streets than traffic and free parking. We also want safety, health, walkability, prosperity, and pleasure.

The Unequal Burden of Parking Requirements

Cities require parking for every building without considering how the required spaces place a heavy burden on poor people. A single parking space, however, can cost more than the net worth of many U.S. households. One study found that in 2015 the average construction cost (excluding land cost) for parking structures was about \$24,000 per space for aboveground parking and \$34,000 per space for underground parking.

By comparison, the U.S. Census of Wealth and Asset Ownership in 2015 found that the median net worth (the value of assets minus debts) was \$110,500 for white households, \$19,990 for Hispanic households and \$12,780 for black households. One space in a parking structure, therefore, costs more than the entire net worth of more than half of all Hispanic and black households in the country.

Free curb parking and off-street parking requirements have spread the city out so

that most people need a car to get a job, go to school, and shop. In a misguided attempt to provide free parking for everyone, cities encourage poor people to buy cars they can ill afford, often financing them by subprime loans at high interest rates. Free parking has the veneer of equality, but it increases inequality. It is enormously wasteful and grossly unfair.

Assumptions and Parking Requirements

Parking requirements resemble what engineers call a “kludge”—an awkward but temporarily effective solution to a problem, with many moving parts that are clumsy, inefficient, hard to understand, and expensive to maintain. Off-street parking requirements are a kludge designed to prevent a shortage of free on-street parking. Parking requirements are superficially plausible but fundamentally wrong.

Parking requirements are like barnacles on a ship, accumulating one at a time and slowing the ship’s progress. They have severed the link between the cost of providing parking and the price that drivers pay for it. They increase the demand for cars, and when citizens object to the resulting traffic congestion, cities respond by restricting development to reduce traffic. That is, cities require parking and then limit the density of people to limit the density of cars. Free parking has become the arbiter of urban form, and cars have replaced people as zoning’s real density concern.

Parking requirements create many disputes about how many parking spaces a building “needs,” with each side making solemn claims backed by dubious evidence. Consider the opposite approaches in the Los Angeles and San Francisco central business districts. For a concert hall downtown, Los Angeles requires, as a minimum, 50 times more parking spaces than San Francisco allows as its maximum. This difference helps to explain why downtown San Francisco is much more exciting than downtown Los Angeles.

If physicians in one city prescribed bloodletting and physicians in another city prescribed blood transfusion to treat the same disease, everybody would demand to know what is going on. Nobody notices when Los Angeles requires parking and San Francisco restricts it. Ultimately, minimum parking requirements increase traffic

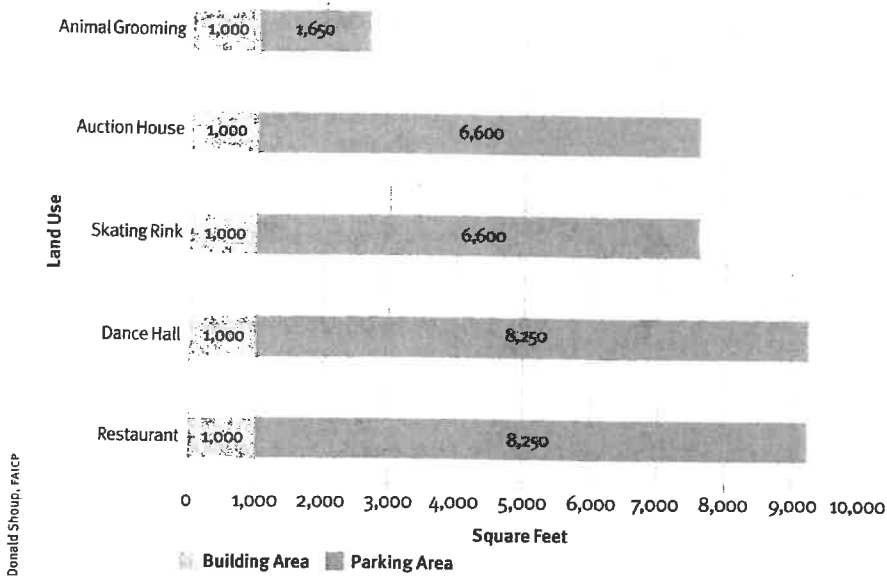

Donald Shoup, FAICP
 Figure 2. Required ratios of building-to-parking area for select uses in San Jose, California.

because all the cars drawn to the required parking spaces clog the roads. Los Angeles has more parking spaces per square mile and worse traffic congestion than any other city in the United States. Minimum parking requirements began as a solution but have become the problem, a disease masquerading as a cure.

If planners assume that every new resident will come with a car, they require developers to provide enough off-street parking to house all the cars. Ample free parking then ensures that most residents do want a car. Parking requirements thus result from a self-fulfilling prophecy. Parking requirements increase the number of cars, and planners then use the large number of cars to justify the need for higher parking requirements.

Planners often use “motivated reasoning” to justify the parking requirements required by elected officials who want enough parking to ensure that citizens won’t yell about a shortage of free parking. Planners must then fashion arguments for conclusions already reached. Assumptions are the starting point of most parking requirements, and the person who makes the assumptions determines the outcome. Instead of reasoning about parking

requirements, planners rationalize them and feign expertise they do not have.

When it comes to parking requirements, planners have used Pandora’s box as their toolkit. These requirements result from complex political and economic forces, and planners are not in full control. But they do enable the pseudoscience, and the public bears the cost.

Every Sin Is Forgiven if It Is Done With Our Permission

When a city requires off-street parking, city officials have something to offer developers—a planning variance that reduces the parking requirement. The city can then allow a business to provide fewer than the required number of parking spaces because of special circumstances. Some planners may believe that minimum parking requirements are needed as a bargaining chip because they enable cities to reduce the parking requirements in exchange for community benefits, such as affordable housing. For example, California requires cities to reduce the parking requirements for residential developments that include a specific share of affordable housing units. Reducing parking requirements as an inducement to provide affordable housing shows how unnecessary

the parking requirements are in the first place. Cities would never reduce the code requirements for safe electrical wiring or fire escapes in exchange for affordable housing units, but they can easily bargain away parking because it is obviously not necessary.

Just as the medieval Catholic Church sold indulgences for the remission of sins, cities can sell planning variances for the remission of parking requirements. In Dostoyevsky’s *The Brothers Karamazov*, the Grand Inquisitor of Seville explained why the Church was popular even though it threatened Hell as the punishment for minor sins: “Every sin will be forgiven if it is done with our permission.” Removing minimum parking requirements will remove the temptation to sell variances that allow sinfully few parking spaces.

How can cities remove their minimum parking requirements and still have the bargaining power the requirements provide? They can establish maximum parking limits and allow developers to provide more spaces if they pay a fee for every space they provide above the limit. I do not recommend establishing parking maximums to use as a bargaining tool with developers. Nevertheless, if cities want to use parking as a bargaining tool, it is much better to bargain from the starting point of maximum limits than of minimum requirements.

THE UPSIDE OF MINIMUM PARKING REQUIREMENTS

The upside of parking requirements is that removing them can do so much good. Figure 1 showed the asphalt desert created by excessive parking in Silicon Valley. What would happen if San Jose removed off-street parking requirements, charged demand-based prices for on-street parking, and used the resulting revenue to improve neighborhood public services? Property owners might decide their land is more valuable for housing than for parking. If a city wants more housing and less traffic, removing off-street parking requirements will help.

Everyone in Silicon Valley complains about expensive housing, long commutes, congested traffic, and polluted air. Building housing on the periphery of parking lots would help to solve all these problems. Figure 3 suggests what could happen if San Jose removed parking requirements and allowed housing on the periphery of



Figure 3. The same office park from Figure 1, digitally altered to illustrate how removing parking requirements could result in liner apartment buildings on previously developed sites.

parking lots. A parking lot can easily be redeveloped because it has a single owner, has no demolition costs, does not require new infrastructure, and is near both jobs and shopping. If apartment buildings fronted the sidewalks, anyone walking, biking, or driving by would see a real city. The smartest way to travel is to be near your destination already, and this job-adjacent housing would allow commuters to walk to work—a rare out-of-car experience.

The housing can be built without new parking because the existing spaces can be shared between office buildings and apartments. To avoid a parking shortage, the cost of parking will have to be separated from the rent for apartments and offices, so only drivers pay for parking. Residents who work in a nearby office building may find they can live with only one or even no car. They will have the option to rent an apartment without paying for two parking spaces, an option that parking requirements now forbid. The new housing cannot cause gentrification or displacement because no one lives on the parking lots now. Converting parking spaces into housing sites will also reduce traffic congestion because more people will walk, bike, carpool, or ride transit to their destinations. Oversized parking lots offer the possibility of something much better, but parking

requirements prevent anything else. The asphalt landscape in too much of America is not walkable, beautiful, or sustainable, but it can be reformed and transformed.

Removing parking requirements can produce a cascade of benefits: shorter commutes, less traffic, a healthier economy, a cleaner environment, and more affordable housing. If we reform our misguided planning, vast parking lots can evolve into real communities. Economic objectives often conflict with environmental objectives, but parking reforms can serve both.

The money we now spend on cars and fuel can be spent on other things. Cars and fuel are often imported, but we cannot import apartment buildings. Spending less for cars, fuel, and parking and spending more for housing will increase the demand for labor in a host of professions, such as architects, carpenters, electricians, plumbers, and roofers. Importing fewer cars and hiring more people to build infill development will boost the whole economy.

Some critics argue that removing an off-street parking requirement amounts to “social engineering” and a “war on cars.” Instead, off-street parking requirements are a war for cars. All the required parking spreads buildings apart so more people need cars to get around. Removing

a requirement that restaurants provide 10 parking spaces per 1,000 square feet of floor area is no more a war on cars than removing a requirement that everyone must eat in restaurants 10 times a month would be a war on restaurants.

When it comes to off-street parking, I’m pro-choice. Cities should not require developers to provide unwanted parking spaces. Parking requirements were a bad idea, poorly executed, and they prevent many good results. Figure 3 shows that an upside of the mess we have made is an accidental land reserve available for job-adjacent housing. If cities remove their unwise parking requirements, we can reclaim land on a scale that will rival the Netherlands.

Cities have three good reasons to remove minimum parking requirements: We can’t afford them, we don’t need them, and they do immense harm. Wishing that parking requirements did not exist, however, is not a strategy for removing them. Parking requirements respond to a real problem, but they are the wrong solution. And cities cannot remove their parking requirements without also better managing on-street parking. If cities manage on-street parking properly, they won’t need to require off-street parking. Information wants to be free, but parking wants to be paid for.

PROOF IT CAN BE DONE

When *The High Cost of Free Parking* was published, half the city planning profession thought I was crazy and the other half thought I was daydreaming. Since then, several cities—including Buffalo, New York; Hartford, Connecticut; Minneapolis, and San Francisco—have removed all parking requirements, and many others have removed their downtown requirements. Mexico City has converted its minimum parking requirements into maximum parking limits while leaving the numbers almost unchanged. What once seemed politically impossible may slowly become the new normal.

For example, in July 2019, Houston nearly doubled the size of its downtown off-street parking exemption area, redefining it as a “market-based parking area” (§26-471(b)(6) & §26-472). In this area, developers decide how much parking to provide, and at least one shopping center developer has already decided to provide a public plaza instead of more parking (DiMiceli 2019).

CONCLUSION

Assembling support for parking reform is like opening a combination lock: each small turn of the dial seems to achieve nothing, but when everything is in place the lock opens. Three reforms can open the parking combination lock: (1) remove off-street parking requirements, (2) charge market prices for on-street parking, and (3) spend the revenue for neighborhood public services:

Repealing off-street parking requirements and replacing them with market prices for on-street parking may at first glance seem a Herculean task, almost like Prohibition or the Reformation, too big an upheaval for society to accept. Nevertheless, this strategy should attract voters across a wide political spectrum. Conservatives will see that it reduces government regulations. Liberals will see that it increases public spending. Environmentalists will see that it reduces

energy consumption, air pollution, and carbon emissions. Urban designers will see that it enables people to live at higher density without being overrun by cars. Developers will see that it reduces building costs. Residents will see that it improves their neighborhood public services. Drivers of all political stripes will see that it guarantees convenient curb parking. Elected officials will see that it depoliticizes parking, reduces traffic congestion, allows infill development, and provides public services without raising taxes. Finally, planners can devote less time to parking and more time to improving cities.

Repealing off-street parking requirements, charging the right prices for on-street parking, and using revenue to provide public services will improve cities, the economy, and the planet, one parking space at a time. Cities will look and work much better when prices, not planners and politicians, govern

decisions about the number of parking spaces. Like the automobile itself, parking is a good servant but a bad master.

Note: This piece is adapted from the Introduction to *Parking and the City*, published by Routledge in 2018.

ABOUT THE AUTHOR

Donald Shoup, FAICP, is Distinguished Research Professor in the Department of Urban Planning at UCLA. His research has focused on how parking policies affect cities, the economy, and the environment. Shoup is a Fellow of the American Institute of Certified Planners and an Honorary Professor at the Beijing Transportation Research Center. In 2015, he received APA's National Excellence Award for a Planning Pioneer.

READINGS

DiMiceli, Vince. 2019. "Houston May Soon Not Have a Problem With Parking." *Streetsblog USA*, September 19. Available at <http://bit.ly/39Y85hW>.

Gabbe, C.J., and Gregory Pierce. 2017. "Hidden Costs and Deadweight Losses: Bundled Parking and Residential Rents in the Metropolitan United States." *Housing Policy Debate*, 27(2): 219–229. Available at <http://bit.ly/2sbaxRz>.

Shoup, Donald, and Don Pickrell. 1978. "Problems with Parking Requirements in Zoning Ordinances." *Traffic Quarterly*, 32(4): 545–563. Available at <http://bit.ly/3a2nMov>.

Shoup, Donald. 1995. "An Opportunity to Reduce Minimum Parking Requirements." *Journal of the American Planning Association*, 61(1): 14–28. Available at <http://bit.ly/2Tb9SKx>.

Shoup, Donald. 1999. "The Trouble with Minimum Parking Requirements," *Transportation Research Part A*, 33A (7–8): 549–574. Available at <http://bit.ly/2NchnNs>.

Shoup, Donald. 2005. Chapter 1. "The 21st Century Parking Problem." In *The High Cost of Free Parking*. Chicago: Planners Press. Available at <http://bit.ly/2tNSn8i>.

Shoup, Donald. 2013. "On-Street Parking Management or Off-Street Parking Requirements." *ACCESS*, Spring. Available at <http://bit.ly/35D1CF>.

Shoup, Donald. 2014. "The High Cost of Minimum Parking Requirements." in *Parking: Issues and Policies*. Bingley, United Kingdom: Emerald Group Publishing. Available at <http://bit.ly/2R4s13l>.

Shoup, Donald. 2016. "Cutting the Cost of Parking Requirements." *ACCESS*, Spring. Available at <http://bit.ly/2Nfamvi>.

Shoup, Donald, ed. 2018. *Parking and the City*. New York: Routledge. Preview available at <http://bit.ly/3ob8JUB>.

Cover: [istock.com/Alex Potemkin](https://www.istock.com/AlexPotemkin)

VOL. 37, NO. 2

The American Planning Association provides leadership in the development of vital communities for all by advocating excellence in planning, promoting education and resident empowerment, and providing our members with the tools and support necessary to ethically meet the challenges of growth and change.

Zoning Practice (ISSN 1548–0135) is a monthly publication of the American Planning Association. Joel Albizo, FASAE, CAE, Chief Executive Officer; Petra Hurtado, PhD, Research Director; Joseph DeAngelis, AICP, and David Morley, AICP, Editors.

Subscriptions are available for \$95 (U.S.) and \$120 (foreign). Missing and damaged print issues: Contact APA Customer Service (312-431-9100 or subscriptions@planning.org) within 90 days of the publication date.

©2020 by the American Planning Association, which has offices at 205 N. Michigan Ave., Suite 1200, Chicago, IL 60601–5927, and 1030 15th St., NW, Suite 750 West, Washington, DC 20005–1503; planning.org.

All rights reserved. No part of this publication may be reproduced or utilized in any form or by any means without permission in writing from APA.

Printed on recycled paper, including 50–70% recycled fiber and 10% postconsumer waste.

NON-PROFIT ORG
U.S. POSTAGE
PAID
APPLETON, WI
PERMIT NO. 39



American Planning Association
Creating Great Communities for All

ZONING PRACTICE
AMERICAN PLANNING ASSOCIATION

205 N. Michigan Ave.
Suite 1200
Chicago, IL 60601-5927



*****AUTO**ALL FOR ADC 060

ANN-MARIE AUBREY
TOWN OF KILLINGLY
PLANNING & DEVELOPMENT OFFICE
172 MAIN ST
KILLINGLY CT 06239-2822

DOES YOUR ZONING FOLLOW
THE PSEUDOSCIENCE OF
PARKING MINIMUMS?

2